



# INTERIOR DOORS

## BROCHURE





# ABOUT MMI DOOR

YOUR DOORWAY TO A BEAUTIFUL HOME

For nearly 70 years, MMI DOOR, a wholly owned subsidiary of JELD-WEN Holdings, Inc., has earned the reputation of being the preferred door supplier to building supply dealers and home centers. With 3 locations, MMI DOOR is a true, single source door provider. We strive to be the most dependable and innovative, value-add fabricator in the marketplace.

Our products are stored, assembled and staged in over 700,000 square feet of heated warehouses. We adhere to rigorous quality control standards to ensure that we provide exceptional value, backed by one of the most extensive and varied inventories nationwide. MMI DOOR offers product choices that are second to none.

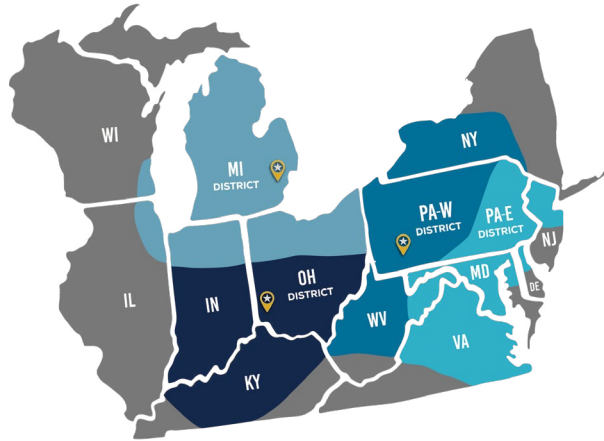

## FEATURING ALL THE BRANDS YOU TRUST

For decades, MMI has been a solutions provider to the multifamily industry, your partner providing beauty, safety and security, through a comprehensive door and door hardware portfolio. You can be assured that the entry products you receive from MMI brands and partners will be the right fit, form and stylish function at the right price to make every project a success.





Impressions Mirror, Molded Door

# TABLE OF CONTENTS

ABOUT MMI	<b>2</b>
DOOR TYPES	<b>5</b>
CHOOSE YOUR DOOR	<b>6-7</b>
HOLLOW & SOLID CORE MOLDED DOORS	<b>8-11</b>
FRENCH DOORS	<b>12-13</b>
PRIMED SHAKER FLAT PANEL DOORS	<b>14</b>
PANEL & LOUVER DOORS	<b>15</b>
FLUSH & PREFINISHED DOORS	<b>16</b>
LITES & LOUVERS	<b>17</b>
BARN DOORS & HARDWARE KITS	<b>18-19</b>
THE MILLENNIUM COLLECTION®	<b>20-21</b>
SLIDING DOOR POCKETS, FRAMES & HARDWARE	<b>22-23</b>
FIRE-RATED DOORS	<b>24-25</b>
COMMERCIAL DOORS & HARDWARE	<b>26</b>
OPTIONS	<b>27</b>
KARONA™ RESIDENTIAL	<b>28-29</b>
SPECIFICATIONS	<b>30</b>
CARE, FINISHING & WARRANTIES	<b>31</b>

**THOUSANDS OF DOOR OPTIONS  
RIGHT AT YOUR FINGERTIPS!**

DOWNLOAD • SNAP • SHARE



GET THE **FREE**  
MOBILE APP  
TODAY!

*Available for all Apple and Android devices.*





## Flush Doors

Common, inexpensive and easy to paint or stain, flush doors are stocked in Primed Hardboard, Red Oak, Birch, and Imperial Oak. They are available in hollow or solid core, unfinished or prefinished, and have optional lites and louvers. Special order species are also available.

## Molded Doors

Molded door skins are made by combining fine wood fibers and resins and then "stamped" into a variety of raised and flat panel designs. Their popularity is due to their value – you get a great-looking door for a great price. Molded doors are available in smooth or woodgrain, hollow or solid core and represent one of the best "bang for your buck value" in the industry.

## Did I Choose the Right Door?

It really comes down to your taste and budget.

Fortunately, MMI DOOR inventories a huge selection for any budget that is available to you within 7-10 days!

If you have more time, our extensive special order options are available to you within 3-6 weeks.

## MDF Doors Medium Density Fiberboard

MDF doors are an affordable step up from solid molded doors. They offer a smoother, denser skin (MDF) that results in a high-quality finished product when painted. Most MDF doors are solid core. Design and sizing possibilities are endless in this category which adds to its popularity.

## Panel Doors Raised Panel, Flat Panel & French

Multiple designs, species and glass options define the top end of the interior door category. Though some wood species can be painted, the majority are stained to showcase their attractive wood grains.

Available in-stock species include Pine and Oak

# CHOOSE YOUR DOOR

## 7 Easy Steps to Choose Your New Interior Door

MMI DOOR has developed a simple, easy-to-follow system outlined below to help you choose the door that's right for you.

### 1 Functionality

This is a critical planning stage; use it wisely. Every opening doesn't require the same door.

- Examples:**
- A) French doors (single or double) can provide light to an adjoining room while maintaining privacy
  - B) Solid core doors look the same on the outside but contain sound-reducing material on the inside. Great for bathrooms, game rooms, music rooms, bedrooms, offices, etc.
  - C) Mirrored doors on a bedroom closet or bathroom door saves space, enlarges the room, and creates additional reflective light
  - D) Doors with frosted glass provide extra light without sacrificing privacy
  - E) Barn doors combine style and practicality while transforming your space to complement the modern home

### 2 Choose a Door Design

Whether you're looking for a traditional style, classic colonial, or something unique, the options are endless. This is your home - make it your own!



3-Lite Frosted, Primed French Door

### 3

## Are You Painting or Staining?

This will narrow your choices:

**Consumer Tips:** Painting offers a fast, cost-effective, and easily changeable option. On the other hand, staining provides a contrasting approach that produces dramatic results.



### 4

## Choose Your Door Jamb

**Consumer Tips:** A. If painting – choose primed.  
 B. If you want to stain your door, choose a species with a grain that matches or closely resembles your door. We offer a range of jamb species to enhance the look of your door. Let's add the wow factor! Don't hesitate to finish the door and trim in different styles. You can find examples throughout this brochure.

### 5

## Choose Your Hinges

Don't forget that hinges can also add a touch of style! Coordinate the hinge finish with the rest of your home's hardware, like locks, light fixtures, and decorative accents. Consider switching to Ball Bearing Hinges for extra strength. They're designed for the most seamless and quiet door movement.

*Only compatible with solid core doors.*

### Round Ball Bearing Hinges

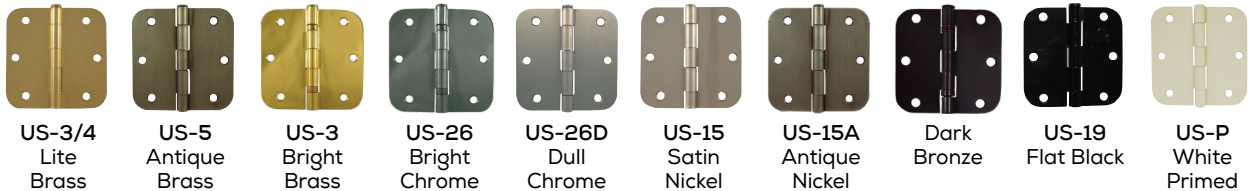

### Square Ball Bearing Hinges



### Self-Closing Hinges



### 6

## Sizing

Double-check the dimensions of each opening, both the width and height. This applies to the door and the space between the door frame (don't forget about the frame depth).

### 7

## Place Your Order!

Please note: availability varies by location.



6-Panel, Pine Panel Door

# HOLLOW & SOLID CORE MOLDED DOORS

## Molded Doors

If you're looking for a wide range of choices, go for interior molded wood fiber doors. They come in various styles, panel designs, and sizes.

Single and double doors are available as prehung units ready to install. They are available in a diverse selection of sizes, jamb species, and decorative hinge finishes.

AVAILABLE 6/8, 7/0, & 8/0 MOLDED DOOR SIZES																
DOOR MODEL	1'0"	1'2"	1'3"	1'4"	1'6"	1'8"	1'10"	2'0"	2'2"	2'4"	2'6"	2'8"	2'10"	3'0"	STICKING PROFILE	BI-FOLDS
<b>BIRKDALE</b>																
6'8" Hollow Core				•	•	•		•	•	•	•	•	•	•	Craftsman	•
6'8" Solid Core					•			•		•	•	•	•	•	Craftsman	
<b>CAIMAN</b>																
6'8" Hollow Core				•	•	•	•	•	•	•	•	•	•	•	Cove & Bead	•
6'8" Solid Core				•	•	•		•	•	•	•	•	•	•	Cove & Bead	
8'0" Hollow Core					•			•	•	•	•	•	•	•	Cove & Bead	
<b>CAMDEN</b>																
6'8" Hollow Core				•	•	•	•	•	•	•	•	•	•	•	Cove & Bead	•
6'8" Solid Core					•			•		•	•	•	•	•	Cove & Bead	
<b>CARRARA</b>																
6'8" Hollow Core				•	•	•	•	•	•	•	•	•	•	•	Cove & Bead	•
6'8" Solid Core				•	•	•		•	•	•	•	•	•	•	Cove & Bead	•
7'0" Solid Core					•			•		•	•	•	•	•	Cove & Bead	
8'0" Hollow Core					•			•	•	•	•	•	•	•	Cove & Bead	
8'0" Solid Core					•			•	•	•	•	•	•	•	Cove & Bead	
<b>COLONIST</b>																
6'8" Hollow Core	•	•	•	•	•	•	•	•	•	•	•	•	•	•	Cove & Bead	•
6'8" Solid Core					•	•		•	•	•	•	•	•	•	Cove & Bead	•
<b>CONMORE</b>																
6'8" Hollow Core					•			•	•	•	•	•	•	•	Stepped	•
6'8" Solid Core					•			•	•	•	•	•	•	•	Stepped	
<b>CRAFTSMAN</b>																
6'8" Hollow Core				•	•	•	•	•	•	•	•	•	•	•	Craftsman	•
6'8" Solid Core					•			•		•	•	•	•	•	Craftsman	
<b>MADISON</b>																
6'8" Hollow Core				•	•	•	•	•	•	•	•	•	•	•	Craftsman	•
6'8" Solid Core					•			•		•	•	•	•	•	Craftsman	
8'0" Solid Core					•			•	•	•	•	•	•	•	Craftsman	
<b>MONROE</b>																
6'8" Hollow Core				•	•	•	•	•	•	•	•	•	•	•	Craftsman	•
6'8" Solid Core					•			•		•	•	•	•	•	Craftsman	
8'0" Solid Core					•			•	•	•	•	•	•	•	Craftsman	
<b>ROCKPORT</b>																
6'8" Hollow Core				•	•	•		•		•	•	•	•	•	Cove & Bead	•
6'8" Solid Core					•			•		•	•	•	•	•	Cove & Bead	
8'0" Hollow Core					•			•	•	•	•	•	•	•	Cove & Bead	
<b>SANTA FE</b>																
6'8" Hollow Core				•	•	•		•	•	•	•	•	•	•	Ovolo	•
6'8" Solid Core					•			•		•	•	•	•	•	Ovolo	
<b>SMOOTH COLONIST</b>																
6'8" Hollow Core	•	•	•	•	•	•	•	•	•	•	•	•	•	•	Cove & Bead	•
6'8" Solid Core					•			•		•	•	•	•	•	Cove & Bead	•
8'0" Hollow Core					•			•	•	•	•	•	•	•	Cove & Bead	
<b>COLONIST/IMPRESSIONS MIRROR</b>																
6'8" Hollow Core								•			•	•		•	Cove & Bead	

• Stocked



# HOLLOW & SOLID CORE MOLDED DOORS

## 6/8 Doors

### Hollow Core



*Smooth Surface*  
**BIRKDALE™**  
Craftsman  
Sticking  
3-Flat Panel



*Smooth Surface*  
**CAIMAN®**  
Cove & Bead  
Sticking  
2-Panel  
Arch Top



*Grained Surface*  
**CAMDEN®**  
Cove & Bead  
Sticking  
2-Panel  
Arch Top



*Smooth Surface*  
**CARRARA®**  
Cove & Bead  
Sticking  
2-Panel



*Grained Surface*  
**COLONIST®**  
Cove & Bead  
Sticking  
6-Panel



*Grained Surface*  
**TWO SIDED DOOR**  
Side A  
**COLONIST®**  
Cove & Bead  
Sticking  
6-Panel



*Grained Surface*  
Side B  
**IMPRESSIONS MIRROR**  
Cove & Bead  
Sticking  
1-Panel



*Smooth Surface*  
**CONMORE®**  
Stepped  
Sticking  
5-Flat Panel



*Smooth Surface*  
**CRAFTSMAN III™**  
Craftsman  
Sticking  
3-Flat Panel



*Smooth Surface*  
**MADISON®**  
Craftsman  
Sticking  
1-Flat Panel



*Smooth Surface*  
**MONROE®**  
Craftsman  
Sticking  
2-Flat Panel



*Smooth Surface*  
**ROCKPORT™**  
Cove & Bead  
Sticking  
5-Panel



*Smooth Surface*  
**SANTA FE™**  
Ovolo  
Sticking  
2-Panel  
Arch Top  
Planked



*Smooth Surface*  
**COLONIST®**  
Cove & Bead  
Sticking  
6-Panel



Birkdale, Molded Door

## STICKING PROFILES

Sticking profile denoted in door description

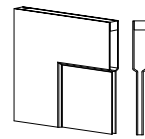

Craftsman  
Sticking

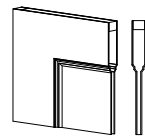

Stepped  
Sticking

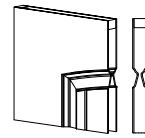

Ovolo  
Sticking

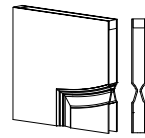

Cove & Bead  
Sticking

# HOLLOW & SOLID CORE MOLDED DOORS

## 6/8 Doors

### Solid Core



*Smooth Surface*  
**BIRKDALE™**  
Craftsman  
Sticking  
3-Flat Panel



*Smooth Surface*  
**CAIMAN®**  
Cove & Bead  
Sticking  
2-Panel  
Arch Top



*Grained Surface*  
**CAMDEN®**  
Cove & Bead  
Sticking  
2-Panel  
Eyebrow



*Smooth Surface*  
**CARRARA®**  
Cove & Bead  
Sticking  
2-Panel



*Grained Surface*  
**COLONIST®**  
Cove & Bead  
Sticking  
6-Panel



*Smooth Surface*  
**CONMORE®**  
Stepped  
Sticking  
5-Flat Panel



*Smooth Surface*  
**CRAFTSMAN III™**  
Craftsman  
Sticking  
3-Flat Panel



Rockport, Molded Door



*Smooth Surface*  
**MADISON®**  
Craftsman  
Sticking  
1-Flat Panel



*Smooth Surface*  
**MONROE®**  
Craftsman  
Sticking  
2-Flat Panel

**PROCORE**  
THE QUIET DOOR™

Consider upgrading to our *solid core doors* that provide more than just warmth and style. **ProCore™** doors reduce noise transmission by 50%, compared to hollow core doors.



*Smooth Surface*  
**ROCKPORT™**  
Cove & Bead  
Sticking  
5-Panel



*Smooth Surface*  
**SANTA FE™**  
Ovolo  
Sticking  
2-Panel  
Arch Top  
Planked



*Smooth Surface*  
**COLONIST®**  
Cove & Bead  
Sticking  
6-Panel

# HOLLOW & SOLID CORE MOLDED DOORS

## 7/0 Doors Solid Core



Smooth Surface  
**CARRARA®**  
Cove & Bead  
Sticking  
2-Panel

## 8/0 Doors Solid Core



Smooth Surface  
**MADISON®**  
Craftsman  
Sticking  
1-Flat Panel



Smooth Surface  
**MONROE®**  
Craftsman  
Sticking  
2-Flat Panel



Smooth Surface  
**CARRARA®**  
Cove & Bead  
Sticking  
2-Panel

## 8/0 Doors Hollow Core



Smooth Surface  
**CAIMAN®**  
Cove & Bead  
Sticking  
2-Panel  
Arch Top



Smooth Surface  
**CARRARA®**  
Cove & Bead  
Sticking  
2-Panel



Smooth Surface  
**ROCKPORT™**  
Cove & Bead  
Sticking  
6-Panel



Smooth Surface  
**COLONIST®**  
Cove & Bead  
Sticking  
6-Panel



Monroe, Molded Door

## STICKING PROFILES

Sticking profile denoted in door description

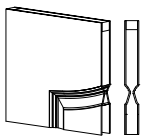

Cove & Bead  
Sticking

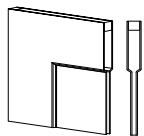

Craftsman  
Sticking

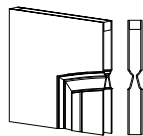

Ovolo  
Sticking

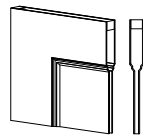

Stepped  
Sticking

**PROCORE**  
THE QUIET DOOR™

# FRENCH DOORS

Enhance the beauty of any interior with our elegantly crafted line of French doors. They add elegance and privacy while maintaining brightness from one room to the next. French doors have tempered glass for extra strength and safety. Most feature a unique glass wrap that makes staining and finishing a snap.



15-Lite True Divided, Pine French Door

AVAILABLE 6/8, 7/0, & 8/0 FRENCH DOOR SIZES								
DOOR MODEL	1'6"	2'0"	2'4"	2'6"	2'8"	2'10"	3'0"	STICKING PROFILE
<b>5-LITE CLEAR</b>								
6'8" Primed	•							Ovolo
6'8" Pine	•							Ovolo
6'8" Oak	*							Ovolo
<b>1-LITE CLEAR</b>								
6'8" Primed	•	•	•	•	•		•	Ovolo
8'0" Primed		•	•	•	•		•	Ovolo
6'8" Pine		•	•	•	•		•	Ovolo
6'8" Oak		*		*	*		*	Ovolo
<b>1-LITE FROSTED</b>								
6'8" Primed		•	•	•	•		•	Ovolo
6'8" Primed		•	•	•	•		•	Shaker
8'0" Primed		•	•	•	•		•	Shaker
<b>1-LITE MIRROR</b>								
6'8" Primed		•	•	•	•		•	Ovolo
6'8" Pine		•	•	•	•		•	Ovolo
<b>10-LITE CLEAR</b>								
6'8" Primed		•	•	•	•		•	Ovolo
6'8" Pine		•	•	•	•		•	Ovolo
6'8" Pine V-Groove		*						Ovolo
6'8" Oak		*						Ovolo
<b>15-LITE CLEAR</b>								
6'8" Primed			•	•	•	•	•	Ovolo
7'0" Primed							•	Ovolo
6'8" Pine			•	•	•		•	Ovolo
6'8" Pine V-Groove			*	*	*		*	Ovolo
6'8" Oak			*	*	*		*	Ovolo
<b>9-LITE CLEAR</b>								
6'8" Primed		•		•			•	Ovolo
<b>1-LITE PANTRY</b>								
6'8" Primed		•	•	•	•			Ovolo
6'8" Pine		•	•	•	•			Ovolo
6'8" Primed Modern		•	•	•	•			Ovolo
<b>1-LITE LAUNDRY</b>								
6'8" Primed				•	•		•	Ovolo
<b>1-LITE WHITE LAMINATED</b>								
6'8" Primed		•	•	•	•		•	Ovolo
<b>1-LITE RAIN</b>								
6'8" Primed		•	•	•	•		•	Ovolo
<b>1-LITE HAMILTON</b>								
6'8" Primed		•	•	•	•		•	Ovolo
<b>3-LITE FROSTED</b>								
6'8" Primed		•	•	•	•		•	Shaker
8'0" Primed		•	•	•	•		•	Shaker
<b>5-LITE FROSTED</b>								
6'8" Primed		•	•	•	•		•	Shaker
8'0" Primed		•	•	•	•		•	Shaker
<b>12-LITE CLEAR</b>								
8'0" Primed		•	•	•	•		•	Ovolo
8'0" Pine		•	•	•	•		•	Ovolo
<b>18-LITE CLEAR</b>								
8'0" Primed				•	•		•	Ovolo

## STICKING PROFILES



Ovolo Sticking



Shaker Sticking

Sticking profile denoted in door description

• Stocked

\*Available as Special Order (available in 3-6 weeks)

# FRENCH DOORS

## 6/8 Doors

### Primed



- 5-LITE CLEAR**  
True Divided  
Ovolo  
Tempered Glass
- 1-LITE CLEAR**  
Ovolo  
Tempered Glass
- 1-LITE FROSTED**  
Obscure  
Ovolo  
Tempered Glass
- 1-LITE MIRROR**  
Ovolo  
Tempered Glass
- 10-LITE CLEAR**  
True Divided  
Ovolo  
Tempered Glass
- 15-LITE CLEAR**  
True Divided  
Ovolo  
Tempered Glass
- 9-LITE CLEAR**  
True Divided  
Ovolo  
Tempered Glass
- 1-LITE PANTRY**  
Obscure  
Ovolo  
Tempered Glass
- 1-LITE PANTRY MODERN**  
Obscure  
Ovolo  
Tempered Glass
- 1-LITE LAUNDRY**  
Obscure  
Ovolo  
Tempered Glass

### Primed



- 1-LITE LAMINATED**  
Obscure  
Ovolo  
Tempered Glass
- 1-LITE RAIN**  
Obscure  
Ovolo  
Tempered Glass
- 1-LITE HAMILTON**  
Obscure  
Ovolo  
Tempered Glass
- 1-LITE FROSTED**  
Shaker  
Tempered Glass
- 3-LITE FROSTED**  
Shaker  
Tempered Glass
- 5-LITE FROSTED**  
Shaker  
Tempered Glass

### Oak



- 5-LITE CLEAR**  
True Divided  
Ovolo  
Tempered Glass
- 1-LITE CLEAR**  
Ovolo  
Tempered Glass
- 10-LITE CLEAR**  
True Divided  
Ovolo  
Tempered Glass
- 15-LITE CLEAR**  
True Divided  
Ovolo  
Tempered Glass

## 6/8 Doors

### Pine



- 5-LITE CLEAR**  
True Divided  
Ovolo  
Tempered Glass
- 1-LITE CLEAR**  
Ovolo  
Tempered Glass
- 1-LITE MIRROR**  
Ovolo  
Tempered Glass
- 10-LITE CLEAR**  
True Divided  
Ovolo  
Tempered Glass
- 15-LITE CLEAR**  
True Divided  
Ovolo  
Tempered Glass
- 15-LITE CLEAR**  
V-Groove  
Ovolo  
Tempered Glass
- 1-LITE PANTRY**  
Obscure  
Ovolo  
Tempered Glass

## 8/0 Doors



- 12-LITE CLEAR**  
True Divided  
Ovolo  
Tempered Glass

## 7/0 Doors

### Primed



- 15-LITE CLEAR**  
True Divided  
Ovolo  
Tempered Glass

## 8/0 Doors

### Primed



- 1-LITE CLEAR**  
Ovolo  
Tempered Glass
- 12-LITE CLEAR**  
True Divided  
Ovolo  
Tempered Glass
- 18 LITE CLEAR**  
True Divided  
Ovolo  
Tempered Glass
- 1-LITE FROSTED**  
Shaker  
Tempered Glass
- 3-LITE FROSTED**  
Shaker  
Tempered Glass
- 5-LITE FROSTED**  
Shaker  
Tempered Glass

**SPECIAL ORDER**  
Available in 3-6 Weeks

# PRIMED SHAKER FLAT PANEL DOORS

Our primed shaker flat panel doors are manufactured to eliminate warp, panel shifting, and rattling so your shaker door performs properly for years to come.



2-Panel, Shaker Door

## 6/8 Doors

Primed



1-PANEL      2-PANEL      CRAFTSMAN      3-PANEL EQUAL      5-PANEL EQUAL

## 8/0 Doors

Primed



1-PANEL      2-PANEL      CRAFTSMAN      3-PANEL EQUAL      5-PANEL EQUAL

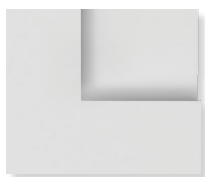

Shaker Sticking

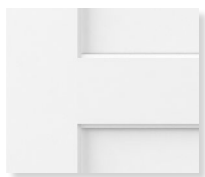

Superior priming – four coats with sanding between coats

AVAILABLE 6/8 & 8/0 PRIMED SHAKER FLAT PANEL DOORS										
DOOR MODEL	1'6"	1'8"	2'0"	2'4"	2'6"	2'8"	2'10"	3'0"	STICKING PROFILE	BI-FOLDS
<b>1-PANEL</b>										
6'8" Primed	•	•	•	•	•	•	•	•	Shaker	•
8'0" Primed*	•		•	•	•	•		•	Shaker	
<b>2-PANEL</b>										
6'8" Primed	•	•	•	•	•	•	•	•	Shaker	•
8'0" Primed	•		•	•	•	•		•	Shaker	
<b>CRAFTSMAN</b>										
6'8" Primed	•	•	•	•	•	•	•	•	Shaker	•
8'0" Primed	•		•	•	•	•		•	Shaker	
<b>3-PANEL EQUAL</b>										
6'8" Primed	•	•	•	•	•	•	•	•	Shaker	•
8'0" Primed	•		•	•	•	•		•	Shaker	
<b>5-PANEL EQUAL</b>										
6'8" Primed	•	•	•	•	•	•	•	•	Shaker	•
8'0" Primed	•		•	•	•	•		•	Shaker	

• Stocked

\*Note: In stock in MI. Special order in OH and PA.

# PANEL & LOUVER DOORS

## Panel Doors

Solid wood panel doors are a classic choice that always stays in style. They are versatile enough to complement any decor, and the natural beauty of wood brings a cozy and inviting atmosphere to every room.

### 6/8 Doors

Pine



4-PANEL



6-PANEL

Oak



6-PANEL



6-Panel, Oak Panel Door

### AVAILABLE 6/8 PANEL DOORS

DOOR MODEL	1'0"	1'2"	1'3"	1'4"	1'6"	1'8"	1'10"	2'0"	2'2"	2'4"	2'6"	2'8"	2'10"	3'0"	STICKING PROFILE	BI-FOLDS
<b>4-PANEL</b>																
6'8" Pine						•			•		•	•		•	Ovolo	•
<b>6-PANEL</b>																
6'8" Pine	•	•	•	•	•	•	•	•	•	•	•	•	•	•	Ovolo	•
6'8" Oak	•	•	•	•	•	•	•	•	•	•	•	•	•	•	Ovolo	•



Full Louver, Primed Louver Door

## Louver Doors

### 6/8 Doors

Primed



FULL LOUVER

Pine



FULL LOUVER



HALF LOUVER

Note: Louver direction is down

### AVAILABLE 6/8 LOUVER DOORS

DOOR MODEL	1'2"	1'3"	1'4"	1'6"	1'8"	1'10"	2'0"	2'2"	2'4"	2'6"	2'8"	2'10"	3'0"	BI-FOLDS
<b>FULL LOUVER</b>														
6'8" Primed				•			•		•	•	•	•	•	•
6'8" Pine	•	•	•	•	•	•	•	•	•	•	•	•	•	•
<b>HALF LOUVER</b>														
6'8" Pine				•			•		•	•	•	•	•	•

• Stocked

# FLUSH & PREFINISHED DOORS

Crafted using select raw materials that undergo precise machining and assembly, these doors are visually appealing and highly dependable. They are designed to withstand the test of time and will continue to serve you for many years.



Birch, Solid Core Flush Door

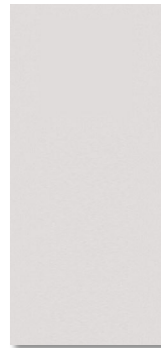

PRIMED  
HARDBOARD

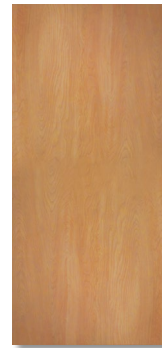

BIRCH



RED OAK

AVAILABLE 6/8 & 7/0 FLUSH DOORS																
DOOR MODEL	1'0"	1'2"	1'3"	1'4"	1'6"	1'8"	1'10"	2'0"	2'2"	2'4"	2'6"	2'8"	2'10"	3'0"	3'6"	BI-FOLDS
<b>PRIMED HARDBOARD</b>																
6'8" Hollow Core	•	•	•	•	•	•	•	•	•	•	•	•	•	•	•	•
8'0" Hollow Core																
6'8" Solid Core						•		•		•	•	•	•	•		
7'0" Solid Core											•	•	•	•		
<b>BIRCH</b>																
6'8" Hollow Core	•	•	•	•	•	•	•	•	•	•	•	•	•	•	•	•
7'0" Hollow Core																
6'8" Solid Core						•		•	•	•	•	•	•	•	•	
7'0" Solid Core											•	•	•	•		
<b>RED OAK</b>																
6'8" Hollow Core				•	•	•	•	•	•	•	•	•	•	•		•
6'8" Solid Core						•		•		•	•	•	•	•		
7'0" Solid Core											•	•	•	•		

Note: Available in Hollow and Solid core & 1-3/8" and 1-3/4" thick flush doors\*

## Prefinished Embossed Hardboard Doors

Our hardboard doors offer an easy and convenient way to upgrade your home with new interior doors. Being prefinished and ready for installation is a major plus!



AVAILABLE 6/8 & 7/0 FLUSH DOORS																
DOOR MODEL	1'0"	1'2"	1'3"	1'4"	1'6"	1'8"	1'10"	2'0"	2'2"	2'4"	2'6"	2'8"	2'10"	3'0"	3'6"	BI-FOLDS
<b>PRIMED HARDBOARD</b>																
6'8" Hollow Core	•	•	•	•	•	•	•	•	•	•	•	•	•	•	•	•
8'0" Hollow Core																
6'8" Solid Core						•		•		•	•	•	•	•		
7'0" Solid Core											•	•	•	•		

• Stocked\*



# LITES & LOUVERS

Revolutionize your flush door with the below lites and louvers to add functional appeal.



20" x 24"



24" x 36"



10" x 10"



10" x 10"

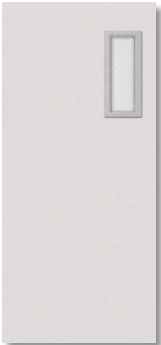

4" x 24"



6" x 36"



20" x 12"  
20" x 24"



20" x 12". Flush Louver Door

# BARN DOORS

Combining both style and practicality, barn doors are a fresh and unique take on a traditional and timeless look.

- Ideal for openings 28"-42" wide
- Unique barn door style hardware enables the door to slide parallel to the wall
- Primed for field finishing
- Barn door hardware kits are also available to be sold separately



Frosted 3-Lite, Primed Barn Door



### K and Z Bar Planked:

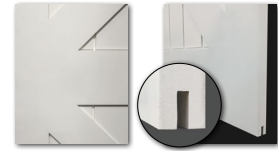

### Frosted 3 and 4-LITE:

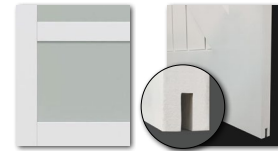

**Stile and Rail Construction**  
Smooth Surface  
Pre-Routed Door Bottom

### Carrara:



**Solid Core**  
Smooth Surface  
Cove & Bead Sticking

1-3/8" 7/0 BARN DOORS									
DOOR MODEL	1'6"	2'0"	2'4"	2'6"	2'8"	2'10"	3'0"	3'6"	STICKING PROFILE
<b>3-LITE FROSTED</b>									
7'0" Primed							•	•	Shaker
<b>4-LITE FROSTED</b>									
7'0" Primed							•	•	Shaker
<b>15-LITE CLEAR</b>									
7'0" Primed							•		Ovolo
<b>CARRARA</b>									
7'0" Primed	•	•	•	•	•	•	•	•	Cove & Bead
<b>K BAR PLANKED</b>									
7'0" Primed							•	•	Shaker
<b>Z BAR PLANKED</b>									
7'0" Primed							•	•	Shaker

• Stocked



Ovolo Sticking



Shaker Sticking

# BARN DOOR HARDWARE KITS

A traditional system is redefined with contemporary styles and finishes to complement the home, office space, or any opening space imaginable. Includes instructions that make it easy for "Do It Yourself" customers.



K Bar Planked, Primed Barn Door

- Hardware kits support 1-3/8" and 1-3/4" thick doors weighing up to 250 lbs
- Kits available in 78-3/4" and 90" track lengths and also includes: door straps, wall spacer, safety anti-jump block, floor guide, and all hardware
- 78-3/4" track is ideal for openings/doors up to 36" wide
- 90" track is ideal for openings/doors between 36" - 42" wide
- Available in three factory finishes ready to install: Matte Black, Brushed Steel and Oil Rubbed Bronze
- Unique barn door-style hardware enables the door to slide parallel to the wall, with one inch offset
- Use for closets, room dividers, or passage door applications
- Available accessories: Track joiner for bi-parting door application, door handle, and recessed door pull
- Special hardware is available. Ask your salesperson

## FINISHES:

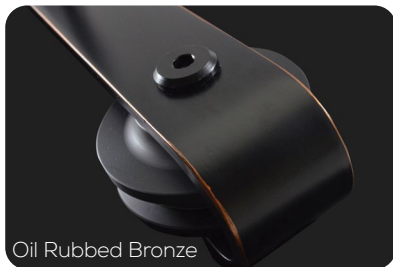

Oil Rubbed Bronze



Stainless Steel



Matte Black

## BARN DOOR KIT OPTIONS:



Matte Black shown

Top of Door Mount Kit



*Oil Rubbed Bronze shown*  
Available in Matte Black, Oil Rubbed Bronze and Stainless Steel

Bent Strap Kit



*Stainless Steel shown*  
Available in Matte Black, Oil Rubbed Bronze and Stainless Steel - BD450

Door Handle



*Stainless Steel shown*  
Available in Matte Black, Oil Rubbed Bronze and Stainless Steel - BD460

Recessed Door Pull

BARN DOOR KITS			
KITS	MATTE BLACK	STAINLESS STEEL	OIL RUBBED BRONZE
Top of Door Mount Kit - Track & Hardware 78-3/4" Track BD101K	•		
Top of Door Mount Kit - Track & Hardware 90" Track BD101K	•		
Bent Strap Mount Kit - Track & Hardware 78-3/4" Track BD102K	•	•	•
Bent Strap Mount Kit - Track & Hardware 90" Track BD102K	•	•	•

# THE MILLENNIUM COLLECTION®

The Millennium Collection consists of four distinct door products that each fit a specific demand in the world of design and construction. *Encore*, *Ovation*, *Infinity*, and *Bravo* Doors are manufactured of renewable composite wood fiber materials for stability and reliability. Our state-of-the-art process and environmentally friendly construction techniques mean endless flexibility for your architectural design. Below are some samples of our standard designs:



1-Panel Encore® Door

## *Encore*

### ROUTER CARVED DOORS

- Dramatic raised panels or grooved options
- Traditional molding profiles
- Made in the USA by proud American craftsmen
- 152 Designs Available

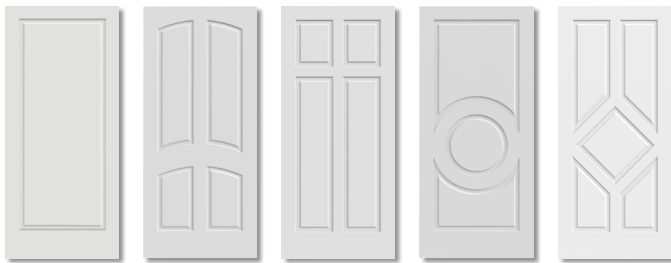

## *Ovation*

### LAYERED PANEL DOORS

- Uniquely layered construction
- Environmentally friendly substrate that will not split or warp
- Made in the USA by proud American craftsmen
- 142 Standard Designs Available

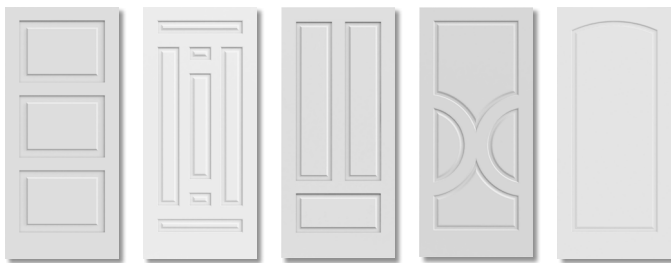

## *Infinity*

### INLAID MOLDING DOORS

- Features dramatic raised panels
- Detailed inlaid molding profiles: Raised, Flush, and Plant-On
- Made in the USA by proud American craftsmen
- 138 Standard Designs Available

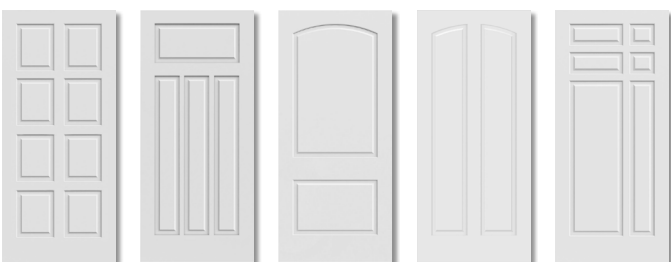

THE  
MILLENNIUM®  
COLLECTION

# THE MILLENNIUM COLLECTION®

*Bravo*

## TRADITIONAL STILE & RAIL DOORS

- Crisp detailed miters and profiles
- Architecturally correct panel configuration
- Made in the USA by proud American craftsmen
- 51 Traditional Designs Available

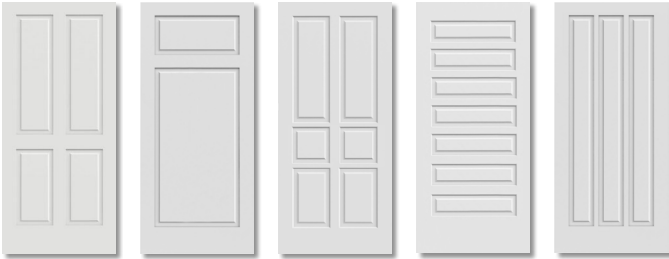

4-Panel Bravo® Door



5-Panel Encore® Door



3-Panel Ovation® Door

Note: Millennium products are special order (available in 3-6 weeks)

# SLIDING DOOR POCKETS & HARDWARE

## Sliding Door Pockets

### Boxed Unit Frame - Unassembled

- Available in 3/0 x 6/8 (door sizes up to) DRPKTKD3068 Universal Frame and Hardware
- 3/0 x 8/0 (door sizes up to) DRPKTKD3080 Universal Frame and Hardware
- Mullion Kit (Join 2 kits together for double door opening)

### Features

- Carton packaged - easy storage and handling
- Steel stiffener reinforcement frame
- Door thickness of 1-3/8" or 1-3/4" and weight up to 125 lbs.
- Four wheel roller on v-groove jump proof track
- Easy adjustment after installation
- Cut marks for easy sizing to standard door widths

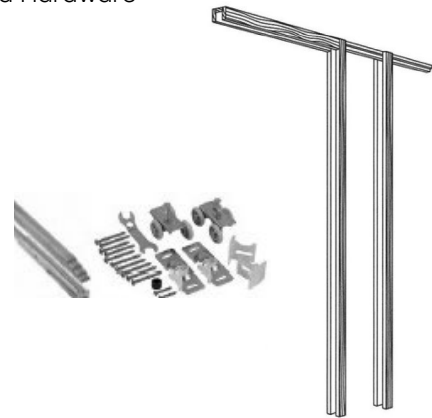

ROUGH OPENING FOR K.D. BOXED FRAME		
DOOR SIZE	6/8 HEIGHT	8/0 HEIGHT
2/0	49-1/4" x 84-1/2"	49-1/4" x 100-1/2"
2/4	57-1/4" x 84-1/2"	57-1/4" x 100-1/2"
2/6	61-1/4" x 84-1/2"	61-1/4" x 100-1/2"
2/8	65-1/4" x 84-1/2"	65-1/4" x 100-1/2"
3/0	73-1/4" x 84-1/2"	73-1/4" x 100-1/2"

### Built Up Frame

### Features

- Built up wood frame for easy installation
- Door thickness of 1-3/8" and weight up to 150 lbs.
- Four wheel roller on v-groove jump proof track
- Easy adjustment after installation

ROUGH OPENING FOR BUILT UP FRAME	
DOOR SIZE	6/8 HEIGHT
2/0	50" x 84"
2/4	58" x 84"
2/6	62" x 84"
2/8	66" x 84"
3/0	74" x 84"

Note: Call for Bypass and Bi-folds rough openings

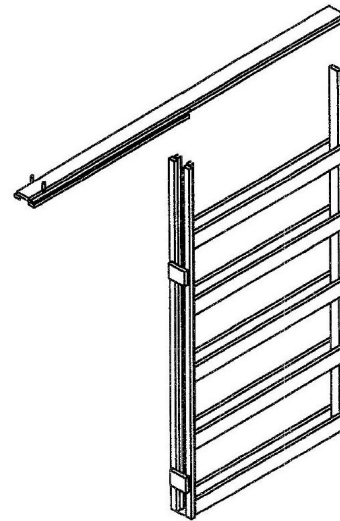

## Bypass Track & Hardware

### #2200



- 4/0 Aluminum #2200 Track and Hardware
- 5/0 Aluminum #2200 Track and Hardware
- 6/0 Aluminum #2200 Track and Hardware

### #2222



- 4/0 Aluminum #2222 Track with Hardware\*
- 5/0 Aluminum #2222 Track with Hardware\*
- 6/0 Aluminum #2222 Track with Hardware\*

\* Note: In stock in OH only. Special order in MI and PA.

### #2200F

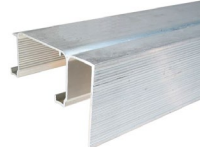

- 4/0 Aluminum #2200F Track with Hardware
- 5/0 Aluminum #2200F Track with Hardware
- 6/0 Aluminum #2200F Track with Hardware



# SLIDING DOOR FRAMES & HARDWARE

## The Premium Pocket Door Solution

The CS Cavity Slider™ is a practical solution for those areas where there is not enough space for a swinging door. Unlike other pocket systems, the CS Cavity Slider™ is structurally robust due to its construction from aluminum extrusions. The CS Cavity Slider™ is suitable for residential and commercial projects as it meets Type 1 construction code without any combustible materials.

### CS Cavity Sliders Frames - 2x4 stud (1-3/8" and 1-3/4" doors)

2'0" x 6'8"	<a href="#">PKTFRAL49162068</a>	2'6" x 8'0"	<a href="#">PKTFRAL49162680</a>
2'6" x 6'8"	<a href="#">PKTFRAL49162668</a>	2'8" x 8'0"	<a href="#">PKTFRAL49162880</a>
2'8" x 6'8"	<a href="#">PKTFRAL49162868</a>	3'0" x 8'0"	<a href="#">PKTFRAL49163080</a>
3'0" x 6'8"	<a href="#">PKTFRAL49163068</a>	4'0" x 8'0"	<a href="#">PKTFRAL49164080</a>

### Stop Carriage Packs

includes carriages, mounting plates, T-Guide, fixing screws & adjusting wrench

<a href="#">PKT1CRGPCK200LB</a>	2-wheel carriages suitable for standard sliding door up to 200lb
<a href="#">PKT1CRGPCK500LB</a>	4-wheel carriages with cast stainless steel body for heavy sliding doors up to 500lb

### CS Sofstop® Single & Double Soft Close

<a href="#">PKT1SGLSS176LB</a>	Single action with one stop up to 200lb (for door widths 2'2" and above)
<a href="#">PKT1DBLSS176LB</a>	Double action with one stop up to 200lb (for door widths 2'2" and above)



7102 Ovation, Pocket Door

## CS Cavity Slider™ Features



# INTERIOR FIRE-RATED DOORS



Smooth Colonist, Fire-Rated Door

## 20-MIN Standard 6/8 Fire Door Units

**FIRE RATING** 20 MIN

The unit Includes:

- 4-9/16" primed 20-minute frame with applied brickmould & weatherstripping
- Composite adjustable sill
- 20-Minute NAMI Fire Label
- Standard 4" hinges, 2 spring/1 standard



Although these door units are not designed to be exposed to the weather (see our Fiberglass Exterior Door Offering); you can perfectly match your interior molded doors with a fire code-compliant "garage-to-home entry door!"

### Molded Fire Door Units



*Smooth Surface*  
**BIRKDALE**  
Craftsman  
Sticking  
3-Flat Panel



*Smooth Surface*  
**CAIMAN**  
Cove & Bead  
Sticking  
2-Panel  
Arch Top



*Smooth Surface*  
**CARRARA**  
Cove & Bead  
Sticking  
2-Panel



*Smooth Surface*  
**CRAFTSMAN**  
Craftsman  
Sticking  
3-Flat Panel



*Smooth Surface*  
**CONMORE**  
Stepped  
Sticking  
5-Flat Panel



*Smooth Surface*  
**ROCKPORT**  
Cove & Bead  
Sticking  
5-Panel



*Smooth Surface*  
**SANTA FE**  
Ovolo  
Sticking  
2-Panel  
Arch Top  
Planked



*Smooth Surface*  
**SMOOTH COLONIST**  
Cove & Bead  
Sticking  
6-Panel  
*(Only Available in 3/0 x 6/8)*

## 20-MIN Millennium Fire Door Units

**FIRE RATING** 20 MIN



1-PANEL



2-PANEL



3-PANEL  
CRAFTSMAN



3-PANEL  
EQUAL



5-PANEL  
EQUAL

- Fire-rated doors are 1-3/4" thick
- Millennium fire-rated doors are also available in 45 and 90 MIN configurations
- Additional special order options available

Note:  
Check local statutes for compliance.  
Please call your local representative for available sizes.  
Codes vary by community. Homeowner must confirm specification requirements.  
All 90-MIN doors come with steel frames. Call for options!



3-Panel Equal, 20 MIN Fire Door



# ENTRY FIRE-RATED DOORS

## 20-MIN Fiberglass Smooth Fire Doors on 20-min Wood Frames

FIRE RATING **20 MIN**



<b>FS 20</b> FIBERGLASS SMOOTH 2-Panel	<b>FS 21</b> FIBERGLASS SMOOTH 6-Panel	<b>FS 22</b> FIBERGLASS SMOOTH 2-Panel	<b>FS 200</b> FIBERGLASS SMOOTH 2-Panel Planked	<b>FS 10 SHK</b> FIBERGLASS SMOOTH 1-Panel Shaker	<b>FS 20 SHK</b> FIBERGLASS SMOOTH 2-Panel Shaker	<b>FS 30 SHK</b> FIBERGLASS SMOOTH 3-Panel Shaker
---	---	---	---	---	---	---

## 90-MIN Fire Doors on Steel Frames

FIRE RATING **90 MIN**



<b>MAJESTIC STEEL</b> MJ-1-90M	<b>MAJESTIC STEEL</b> MJ-20-90M	<b>MAJESTIC STEEL</b> MJ-21-90M	<b>MAJESTIC STEEL</b> MJ-22-90M	<b>MAJESTIC STEEL</b> MJ-40-90M
---------------------------------------	--	--	--	--



<b>MAJESTIC STEEL</b> MJ-300-90M	<b>10 CRF 90M MAJESTIC STEEL</b> 1-Panel	<b>20 CRF 90M MAJESTIC STEEL</b> 2-Panel	<b>30 CRF 90M MAJESTIC STEEL</b> 3-Panel
---	---	---	---



30 CRF 90M, Majestic Steel

Note:  
Please call your local representative for available sizes.  
Codes vary by community. Homeowner must confirm specification requirements.  
All 90-MIN doors come with steel frames. Call for options!

# COMMERCIAL DOORS & HARDWARE

## 20-MIN, 45-MIN & 90-MIN Commercial & Residential Flush doors

### Unfinished & Prefinished Doors



<i>Unfinished</i>	<i>Unfinished</i>	<i>Unfinished</i>	<i>Unfinished</i>	<i>Unfinished</i>	<i>Prefinished</i>	<i>Prefinished</i>	<i>Prefinished</i>	<i>Prefinished</i>
Rotary Natural Birch	Economy Birch	Plain Sliced Red Oak	Quarter Sliced African Mahogany	Plain Sliced White Maple	Plain Sliced Red Oak	Plain Sliced White Maple	Colledgeguard	Primed Hardboard

Note:  
Available in 20-Min, 45-Min and 90-Min configurations.  
Please call your local representative for available fire rating configuration and sizes.  
Codes vary by community. Homeowner must confirm specification requirements.  
All 90-MIN doors come with steel frames. Call for options!











## Commercial Hardware (Interior & Exterior Application)









MMI DOOR stocks a full line of commercial doors, frames and hardware. We offer a variety of commercial hardware such as self-closing hinges, automatic door closers, panic devices, and more to suit most applications.



# OPTIONS

SINGLE DOOR PREHUNG JAMB OPTION:		PRIMED		PINE VENEER WOOD BACK		OAK VENEER WOOD BACK		PREFINISHED EMBOSSED	
		Single	Double	Single	Double	Single	Double	Single	Double
4-9/16" Primed	6/8 Unit	*	*	*	*	*	*	*	*
4-9/16" Primed	7/0 Unit	*	*	*	*	*	*	*	*
4-9/16" Primed	8/0 Unit	*	*	*	*	*	*	*	*
4-13/16" Primed	6/8 Unit	*	*	*	*	*	*	*	*
4-13/16" Primed	7/0 Unit	*	*	*	*	*	*	*	*
4-13/16" Primed	8/0 Unit	*	*	*	*	*	*	*	*
5-1/4" Primed	6/8 Unit	*	*	*	*	*	*	*	*
6-7/8" Primed	7/0 Unit	*	*	*	*	*	*	*	*
6-7/8" Primed	7/0 Unit	*	*	*	*	*	*	*	*
6-7/8" Primed	7/0 Unit	*	*	*	*	*	*	*	*
6-7/8" Primed	8/0 Unit	*	*	*	*	*	*	*	*
6-7/8" Primed	8/0 Unit	*	*	*	*	*	*	*	*
6-7/8" Primed	8/0 Unit	*	*	*	*	*	*	*	*
6-9/16" Primed	6/8 Unit	*	*	*	*	*	*	*	*
6-9/16" Primed	7/0 Unit	*	*	*	*	*	*	*	*
6-9/16" Primed	8/0 Unit	*	*	*	*	*	*	*	*
7-1/4" Primed	6/8 Unit	*	*	*	*	*	*	*	*
4-9/16" Pine Veneer Wood Back	6/8 Unit	*	*	*	*	*	*	*	*
4-9/16" Solid Pine	6/8 Unit	*	*	*	*	*	*	*	*
4-9/16" Solid Pine	7/0 Unit	*	*	*	*	*	*	*	*
4-9/16" Solid Pine	8/0 Unit	*	*	*	*	*	*	*	*
5-1/4" Solid Pine	6/8 Unit	*	*	*	*	*	*	*	*
5-1/4" Solid Pine	7/0 Unit	*	*	*	*	*	*	*	*
6-9/16" Solid Pine	6/8 Unit	*	*	*	*	*	*	*	*
7-1/4" Solid Pine	6/8 Unit	*	*	*	*	*	*	*	*
7-1/4" Solid Pine	7/0 Unit	*	*	*	*	*	*	*	*
7-1/4" Solid Pine	8/0 Unit	*	*	*	*	*	*	*	*
9-1/4" Solid Pine	6/8 Unit	*	*	*	*	*	*	*	*
9-1/4" Solid Pine	7/0 Unit	*	*	*	*	*	*	*	*
9-1/4" Solid Pine	8/0 Unit	*	*	*	*	*	*	*	*
11-1/4" Solid Pine	6/8 Unit	*	*	*	*	*	*	*	*
11-1/4" Solid Pine	7/0 Unit	*	*	*	*	*	*	*	*
11-1/4" Solid Pine	8/0 Unit	*	*	*	*	*	*	*	*
4-9/16" Solid Poplar	6/8 Unit	*	*	*	*	*	*	*	*
4-9/16" Solid Poplar	7/0 Unit	*	*	*	*	*	*	*	*
4-9/16" Solid Poplar	8/0 Unit	*	*	*	*	*	*	*	*
4-13/16" Solid Poplar	6/8 Unit	*	*	*	*	*	*	*	*
4-13/16" Solid Poplar	7/0 Unit	*	*	*	*	*	*	*	*
4-13/16" Solid Poplar	8/0 Unit	*	*	*	*	*	*	*	*
6-9/16" Solid Poplar	6/8 Unit	*	*	*	*	*	*	*	*
9-1/4" Solid Poplar	6/8 Unit	*	*	*	*	*	*	*	*
9-1/4" Solid Poplar	7/0 Unit	*	*	*	*	*	*	*	*
9-1/4" Solid Poplar	8/0 Unit	*	*	*	*	*	*	*	*
4-9/16" Oak Veneer Wood Back	6/8 Unit	*	*	*	*	*	*	*	*
4-9/16" Solid Oak	6/8 Unit	*	*	*	*	*	*	*	*
4-9/16" Solid Oak	7/0 Unit	*	*	*	*	*	*	*	*
4-9/16" Solid Oak	8/0 Unit	*	*	*	*	*	*	*	*
4-13/16" Solid Oak	6/8 Unit	*	*	*	*	*	*	*	*
4-13/16" Solid Oak	7/0 Unit	*	*	*	*	*	*	*	*
5-1/4" Solid Oak	6/8 Unit	*	*	*	*	*	*	*	*
5-1/4" Solid Oak	7/0 Unit	*	*	*	*	*	*	*	*
6-9/16" Solid Oak	6/8 Unit	*	*	*	*	*	*	*	*
7-1/4" Solid Oak	6/8 Unit	*	*	*	*	*	*	*	*
7-1/4" Solid Oak	7/0 Unit	*	*	*	*	*	*	*	*
9-1/4" Solid Oak	6/8 Unit	*	*	*	*	*	*	*	*
9-1/4" Solid Oak	7/0 Unit	*	*	*	*	*	*	*	*
4-9/16" PF Embossed Imperial Oak	6/8 Unit	*	*	*	*	*	*	*	*
4-13/16" PF Embossed Imperial Oak	6/8 Unit	*	*	*	*	*	*	*	*
4-1/4 - 4-3/4" Primed Split Jamb	6/8 Unit	*	*	*	*	*	*	*	*
4-1/4 - 4-3/4" Solid Pine Split Jamb	6/8 Unit	*	*	*	*	*	*	*	*
4-1/4 - 4-3/4" PF Emb. Imperial Oak Split Jamb	6/8 Unit	*	*	*	*	*	*	*	*

	11/16" x 2-1/4" 327 Primed Casing
	11/16" x 2-1/4" 366 Primed Casing
	11/16" x 2-1/4" 356 Primed Casing
	11/16" x 2-1/4" 376 Primed Casing
	11/16" x 3-1/4" 445 Primed Casing
	11/16" x 3-1/4" 444 Primed Casing
	11/16" x 2-5/8" CM1 Primed Casing
	11/16" x 2-3/4" CM 299 Primed Casing
	11/16" x 3-1/2" CM 450 Primed Casing
	9/16" x 3-1/2" MDF CRF Casing
	1-1/16"x3-1/2" 97 Primed Casing

CASED OPENINGS	
MITERED CASING SETS	
	11/16" x 2-1/4" 356 Imperial Oak Casing
	9/16" x 2-1/4" 356 Red Oak Casing
	11/16" x 2-1/4" 356 Primed MDF Casing
	11/16" x 2-1/4" 327 Pine Casing
	11/16" x 2-1/4" 356 Pine Casing
	11/16" x 2-1/4" 376 Pine Casing
	11/16" x 2-1/2" 361 Pine Casing
	11/16" x 3-1/4" 445 Pine Casing

\* *Varies by location. Additional lead time may apply.*

\* = Stocked

# KARONA™ RESIDENTIAL

Expertly crafted for high-end homes and commercial spaces, Karona™ interior doors are distinctive and beautiful, capturing the substantial feel and warm appearance of real wood. Choose from dozens of timeless door designs or create your own custom solution. Karona™ doors present a wealth of options for creating an elevated look and getting the finest of details right – including more than 20 wood species, decorative glass choices, and more.

## TRADITION MEETS TECHNOLOGY

Karona™ doors blend precise production technology with skillful team craftsmanship to produce a stunning appearance and lasting performance.

## STABILITY IS BUILT IN

The Karona™ Solid Core material resists expansion, contraction, and cracking, and its premium wood veneers meet or exceed industry standards.

## COMPREHENSIVE CUSTOM CAPABILITIES

Karona™ can turn your concepts into a design, develop construction and aesthetic details, and present you with drawings for approval. From wood species, sticking, and custom stains to glass and more, choose the best options for your projects.

Limited Lifetime for Interior Use, Karona offers 20-minute, 45-minute, 60-minute, and 90-minute fire rated options. Please call your local representative for more information

### GLASS



RAIN



FLEMISH



REEDED



VELOUR

### SPECIES



ALDER



WHITE OAK



MAPLE



WALNUT

### STICKING



SQUARE



OVOLO



OGEE



MISSION

### STAINS



KHAKI



BROWN SUGAR



SUNTAN



CHOCOLATE

CRAFTSMAN



LOUVER



DISTINCTIVE DESIGN



CLASSIC



FRENCH



KARONA  
RESIDENTIAL



# SPECIFICATIONS

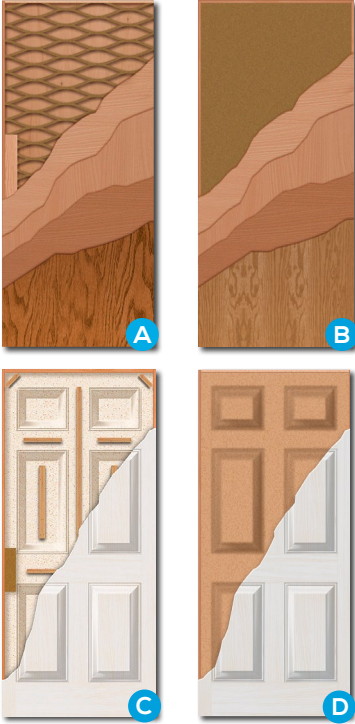

## Cores, Handings & Rough Openings

### Flush Door Cores:

- A. Hollow Core:**
  - Combination Wood/MDF Frame
  - Corrugated honeycomb cell core
  - 1-5/32" MDF stiles - optional wood stiles
  - Optional wood top and bottom rails in customer-specified widths
  - 1/8" premium hardwood veneers or pre-primed hardboard
- B. Solid Core:**
  - Wood or MDF Frame
  - 1-5/32" MDF top & bottom rails
  - Optional wood top and bottom rails in customer-specified widths
  - 1/8" premium hardwood veneers, pre-primed or unprimed hardboard

### Molded Door Cores:

- C. Hollow Core:**
  - MDF Frame
  - 1-5/32" MDF top & bottom rails
  - Blocking behind panels for support
  - Two particleboard lock blocks
  - Optional wood top and bottom rails in customer-specified widths
- D. Solid Core:**
  - Wood Frame
  - MDF top and bottom rails optional
  - 1/8" HDF facings
  - 1-1/4" wood top and bottom rails in customer-specified widths

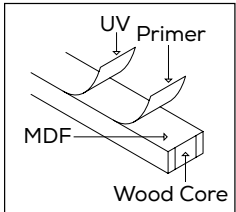

### The Finish:

Each door is individually finished with a UV sealer system. Applied before the finishing coat, sealing the wood, removing all traces of cracks and crevices in the joints and tones down brush strokes, knots and woodgrain.

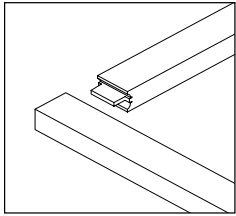

### Tenon & Mortise Joint:

High-quality construction with an adhesive binding technique that gives the joints exceptional strength and a lasting hold.

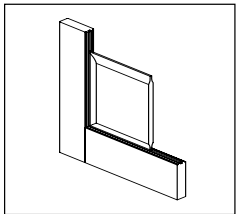

### Panels:

Medium Density Fiber panels are incorporated in each panel for a stable door, resistant to expansion which helps to protect from cracks and leaks.

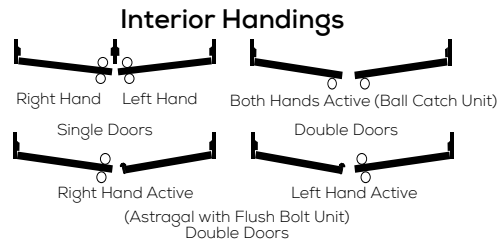
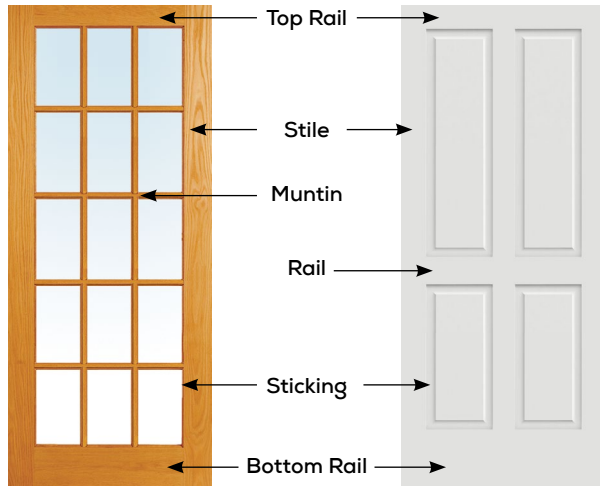

## Door Openings

	SINGLE DOOR WIDTH						DOUBLE DOOR WIDTH*					HEIGHT		
NOMINAL DOOR SIZE	1/6	2/0	2/4	2/6	2/8	3/0	3/0	4/0	4/8	5/0	5/4	6/0	6/8	8/0
Rough Opening Required	20"	26"	30"	32"	34"	38"	38"	50"	58"	62"	66"	74"	82-1/4"	98-1/4"
Unit Dimension	19-1/2"	25-1/2"	29-1/2"	31-1/2"	33-1/2"	37-1/2"	37-1/2"	49-1/2"	57-1/2"	61-1/2"	65-1/2"	73-1/2"	81-1/2"	97-1/2"

\*Double door unit dimensions shown are for units with ball catch only. For double door units with an astragal, add 1/2" to the width.

# CARE, FINISHING & WARRANTIES

Proper care and maintenance of your newly installed interior doors is crucial. Despite their simplicity, neglecting these guidelines often leads to avoidable damage.

- Doors stored for more than a few days should have the top and bottom rails sealed. Do not drag doors or walk on them.
- Single door slabs (not prehung doors) should be laid flat on a dry, clean surface.
- Do not subject them to extreme or rapid changes in humidity or heat.

## Finishing

Proper care and finishing are critical to maximize your interior doors' benefits. If done right, a correctly applied finish will help you achieve a longer-lasting, higher-quality product that exceeds your aesthetic and operational expectations. Below are a few key points everyone should know when it comes to the care and finishing of interior doors.

- All doors have six sides – front, back, two edges, plus the most ignored and most vulnerable, the top and bottom. Failure to finish all six surfaces uniformly is the number one cause of door failures.
- No finishing process that eliminates the transmission of water vapor or moisture into and out of wood doors exists today. The key to proper finishing is slowing down the transmission process so the door performs tolerably.
- Sanding is a critical component of any finishing process. All doors may have visible and invisible blemishes from handling or other naturally occurring characteristics. Sanding techniques vary by door type and must be followed to achieve a quality finish.
- Natural wood doors (pine, poplar, oak, etc.) contain color, tone, and graining variations that occur in the natural process. Applying a pre-stain wood conditioner promotes a uniform appearance and minimizes sharp color contrasts. Carefully follow the manufacturer's instructions for wood conditioner application.
- Oil-based products are recommended for interior wood-veneered doors. Water-based products can raise the grain and cause multiple moisture related problems. Latex or oil-based paint is suitable for interior molded doors.

For more detailed information, please refer to the manufacturer's care, finishing, and maintenance directions located on our website – [www.mmidoor.com](http://www.mmidoor.com)

Note: The color and texture of the doors shown in the catalog are not a 100% actual representation of the doors.

## Warranty

At MMI DOOR, interior doors are produced to exacting standards, regardless of the manufacturer. Based on decades of superior performance, we warrant our interior doors from defects in material or artistry for a period of 5 years when they are:

- Properly installed
- Properly finished (paint or stain)
- Properly cared for and maintained on all 6 sides



Madison, Molded Door



**5 Year**  
**Limited Warranty**

For more information on MMI DOOR products and services, please visit:

[www.mmidoor.com](http://www.mmidoor.com)



## MMI DOOR LOCATIONS

### Michigan (HQ)

6361 Sterling Drive North  
Sterling Heights, MI 48312  
586.264.0950  
800.686.9218  
Fax: 586.264.5430

### Ohio

400 Circle Freeway Drive  
Cincinnati, OH 45246  
513.874.6771  
800.215.3770  
Fax: 513.870.0242

### Pennsylvania

172 Plummer Road  
Sidman, PA 15955  
814.487.7800  
800.452.0251  
Fax: 814.487.7850