



COMMERCIAL DOORS

BROCHURE



Flush Steel Door
Standard Duty Commercial Rim Exit Device
Finished in Field



ABOUT MMI DOOR

YOUR DOORWAY TO A BEAUTIFUL HOME

For over 60 years, MMI DOOR, a wholly owned subsidiary of JELD-WEN Holdings, Inc., has earned the reputation of being the preferred door supplier to building supply dealers and home centers. With 3 locations, MMI DOOR is a true, single source door provider. We strive to be the most dependable and innovative, value-add fabricator in the marketplace.

Our products are stored, assembled and staged in over 700,000 square feet of heated warehouses. Strict quality control standards are followed, allowing us to deliver maximum value. With one of the largest and most diverse inventories in the country, MMI DOOR offers product choices that are second to none.

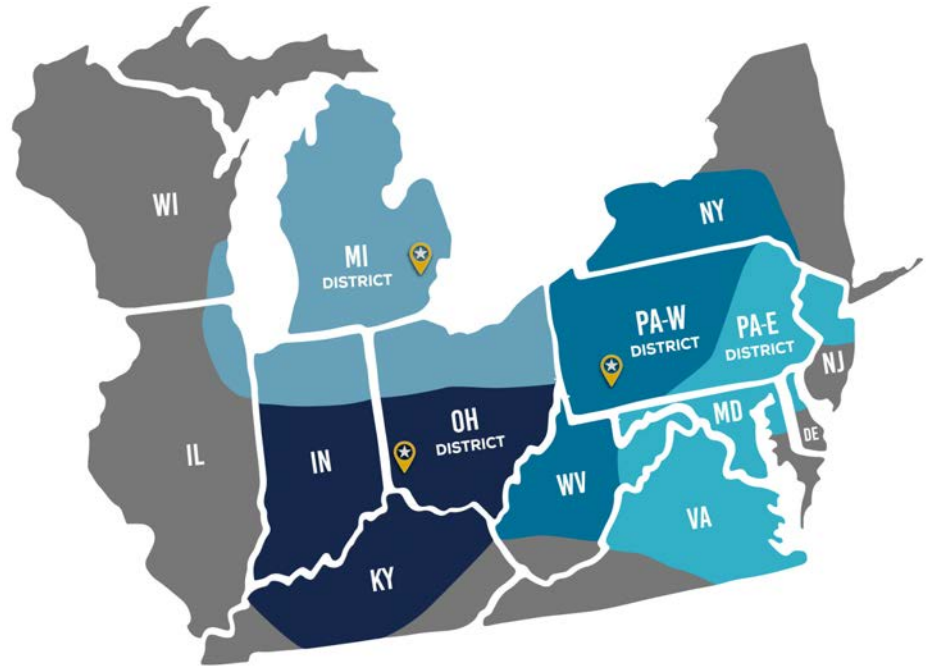

ABOUT JELD-WEN

DEDICATION FROM DAY ONE

Since 1960, when JELD-WEN began with one millwork plant, we've been dedicated to crafting windows and patio doors that enhance the beauty and functionality of your home. Today we continue that tradition with products that are durable and worry-free. It's the result of innovation as a driving force in all that we do.

It begins in the forests where we harvest our premium lumber. In addition to responsible reforestation practices, we recycle as much of our raw resources as possible. Innovation is also at the heart of our design and manufacturing process. With JELD-WEN, you can expect products that are more than just beautiful on the outside. The inner workings of our doors are engineered to function flawlessly for years to come.

COMMERCIAL DOORS

HANDINGS & SIZES

COMMERCIAL DOOR HANDINGS (VIEWED FROM KEYED SIDE OF DOOR)

INSWING



OUTSWING



OPENING SIZES FOR STEEL FRAMES SLIP-ON DRYWALL APPLICATION

Drywall Frame

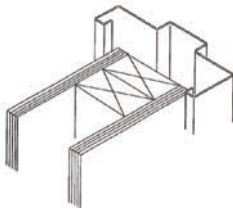

Rough Opening

Door Size	Width	Height
2/6 x 6/8	32"	81"
2/8 x 6/8	34"	81"
3/0 x 6/8	38"	81"
3/6 x 6/8	44"	81"
4/0 x 6/8	50"	81"
6/0 x 6/8	74"	81"
3/0 x 7/0	38"	85"
3/6 x 7/0	44"	85"
4/0 x 7/0	50"	85"
6/0 x 7/0	74"	85"

Head and side frame face dimension 2"

Adjustable Frame

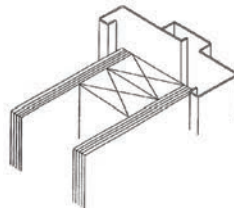

Rough Opening

Door Size	Width	Height
3/0 x 6/8	37-5/8"	81-1/4"
6/0 x 6/8	73-5/8"	81-1/4"
3/0 x 7/0	37-5/8"	85-1/4"
6/0 x 7/0	73-5/8"	85-1/4"

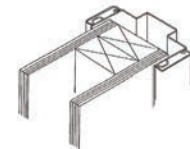

A Series

Rough Opening

Door Size	Width	Height
2/8 x 6/8	33-1/4"	81"
3/0 x 6/8	37-1/4"	81"
6/0 x 6/8	73-1/4"	81"
3/0 x 7/0	37-1/4"	85"
6/0 x 7/0	73-1/4"	85"

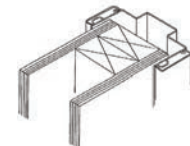

C Series

Rough Opening

Door Size	Width	Height
2/8 x 6/8	33-1/4"	81"
3/0 x 6/8	37-1/4"	81"
2/8 x 7/0	33-1/4"	85"
3/0 x 7/0	37-1/4"	85"
2/8 x 8/0	33-1/4"	97"
3/0 x 8/0	37-1/4"	97"

COMMERCIAL DOORS

SIZES

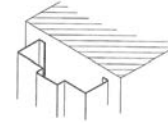

Universal Frame		Butted Application		Unit Dimension	
Door Size	Head Frame	Rough Opening		Width	Height
	Face Dimension	Width	Height		
2/6 x 6/8	2"	34-1/4"	82-1/8"	34"	82"
2/8 x 6/8	2"	36-1/4"	82-1/8"	36"	82"
2/10 x 6/8	2"	38-1/4"	82-1/8"	38"	82"
3/0 x 6/8	2"	40-1/4"	82-1/8"	40"	82"
3/6 x 6/8	2"	46-1/4"	82-1/8"	46"	82"
4/0 x 6/8	2"	52-1/4"	82-1/8"	52"	82"
6/0 x 6/8	2"	76-1/4"	82-1/8"	76"	82"
2/6 x 7/0	2"	34-1/4"	86-1/8"	34"	86"
2/8 x 7/0	2"	36-1/4"	86-1/8"	36"	86"
3/0 x 7/0	2"	40-1/4"	86-1/8"	40"	86"
3/0 x 7/0	4"	40-1/4"	88-1/8"	40"	86"
3/6 x 7/0	2"	46-1/4"	86-1/8"	46"	86"
4/0 x 7/0	2"	52-1/4"	86-1/8"	52"	86"
6/0 x 7/0	2"	76-1/4"	86-1/8"	76"	86"
6/0 x 7/0	4"	76-1/4"	88-1/8"	76"	88"

Custom head & face dimensions available upon request



COMMERCIAL SOLUTIONS

ORDERING PROCESS

Sourcing commercial products can be complicated, time consuming and frustrating. Our program is designed to simplify that process.

It is driven by:

- **Simplicity** – We make it easy for you and your customer.
- **Speed** – Commercial products delivered at residential speeds.
- **Convenience** – One stop shop concept; residential and commercial products from one source.

Today, value added services are required to minimizing errors and lowering job site costs. Our program provides unique services to lower your costs and improve the overall process. Such as:

- **Prehanging** – Many light commercial and fire doors can actually be prehung.
- **Prefinishing** – We provide residential, commercial doors and frames painted in 19 popular colors.

WE MAKE THE ORDERING PROCESS SIMPLE!

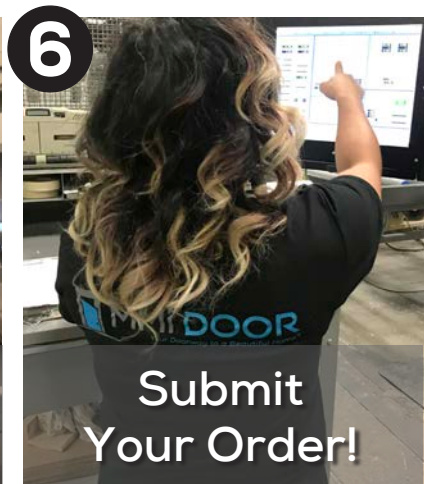
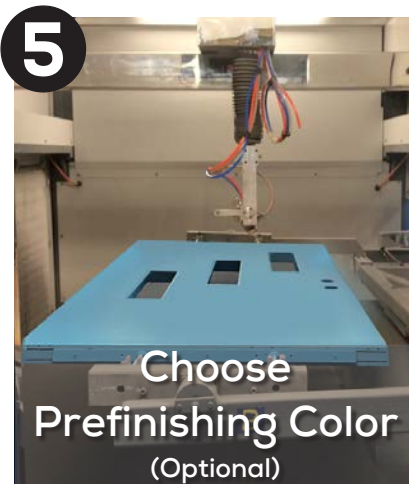
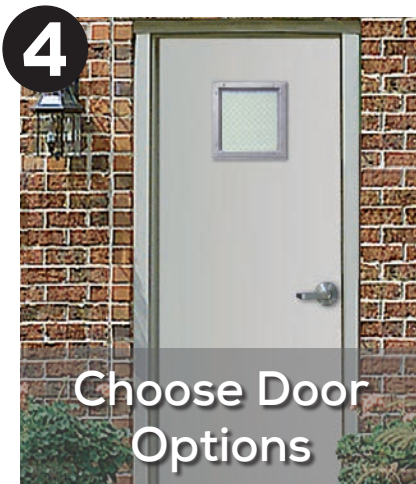

COMMERCIAL DOOR FRAMES

HEAVY DUTY COMMERCIAL APPLICATION

HOLLOW METAL 5-3/4" (SU)* FRAME

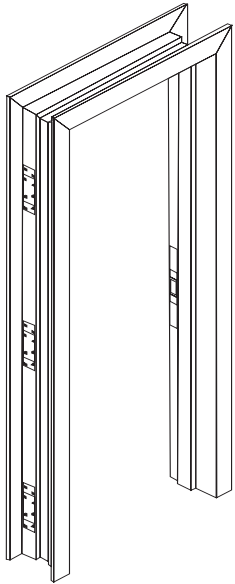

MODEL: SU Frame

SIZES AVAILABLE: Other sizes and profiles available special order

Will work with block walls, poured walls, metal studs or wood studs for new construction and/or existing construction

FIRE RATING: 3 Hour Mylar Label Available

FRAME MATERIAL: 16 Gauge - Galvanized - Primed

INSTALLATION READY: Assembled and Welded

HINGES & LOCK STRIKE PREPARATIONS: (3) 4-1/2" Square Corner Hinges & 4-7/8" Strike Prep

MUTES: (3) Rubber Mutes

HANDED FOR LEFT OR RIGHT SWING

MASONRY WIRE ANCHOR OR MULTIPURPOSE ANCHOR

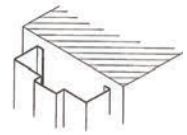
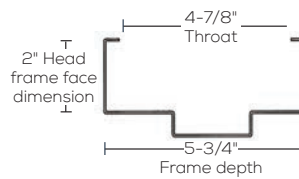
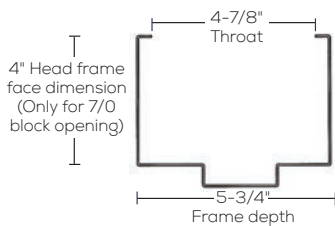

Universal Application

(Interior & Exterior Application)



Wood Screws



Dynabolts

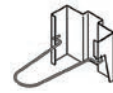

Masonry Wire Anchor



Multipurpose Anchor

STEEL FRAME ADJUSTABLE DRYWALL

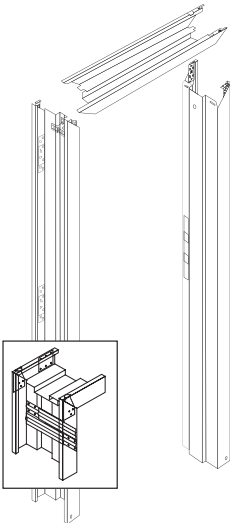

MODEL: 16 Gauge Adjustable Steel Frame

FIRE RATING: 90 Minute NAMI Label Embossment

Standard on 6'8 and 7'0" Hinge Jamb

FRAME MATERIAL: A40 Paintable Galvaneal Steel - Unprimed

INSTALLATION READY: Mechanical Knock Down Corner Connection

HINGES & LOCK STRIKE PREPARATIONS: (3) 4-1/2"

High Hinge Reinforcements

& ASA (4-7/8") Strike Prep

FRAME OPENING: All Double Heads Undersized by 1/8" from Nominal Width

FRAME MOUNTING: Faces Punched and Dimpled for Wall Anchoring

MUTES: (3) Rubber Mutes & Bumper/Silencer Holes (3 at Strike Jamb and 2 at Double Heads)

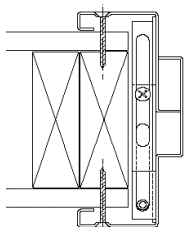

Adjustable Application

(Interior & Exterior Application)

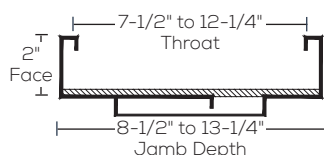
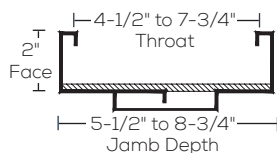

DU DRYWALL FRAME

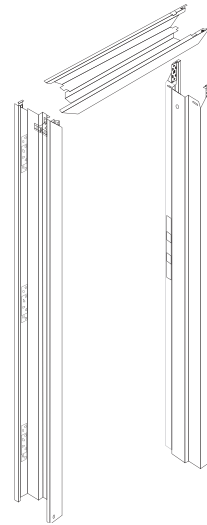

MODEL: Hollow Metal Steel DU Drywall Frame

FIRE RATING: 1-1/2 (90 Minute)

Fire Rating Mylar Label

FRAME MATERIAL: 16 Gauge - Cold Rolled - Primed

INSTALLATION READY: Knock Down, Ready to Install

HINGES & LOCK STRIKE PREPARATIONS: (3) 4-1/2"

Square Corner Hinges & 4-7/8" Strike Prep

HANDED FOR LEFT OR RIGHT SWING

4 TAB INTERLOCKING SYSTEM

MUTES: (3) Rubber Mutes

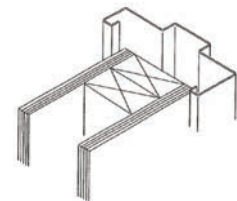
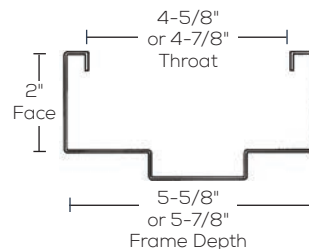

Drywall Application

(Interior Application Only)

LIGHT COMMERCIAL DOOR FRAMES

RESIDENTIAL OR LIGHT COMMERCIAL APPLICATION

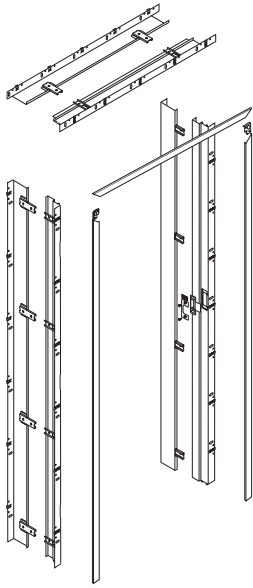

A-SERIES ADJUSTABLE STEEL FRAME

MODEL: Timely A-Series Adjustable Steel Frame
FIRE RATING: 1-1/2 Hour (90 Minute)
FINISH: Prefinished in Browntone or Western White
FRAME MATERIAL: 18 Gauge Galvanized Powder Coated Steel
INSTALLATION READY: Knock Down
THROAT: 3-3/4" - 5-1/2", 5-5/8" - 7-3/8", or 6-5/8" - 8-3/8"
HINGES & LOCK STRIKE PREPARATIONS: (3) 4-1/2" Square Corner Hinges & 4-7/8" Strike Prep
CASING TYPE: Prepped for 2 Sets of Steel Casing (TA-8)
CASING OPTIONS: Colonial (TA-30 Steel), Aluminum (TA-23), Wide Aluminum (TA-28), or Wood
MUTES: Stick-On Rubber Bumper Pads - Rubber Silencer Prep is NOT Available

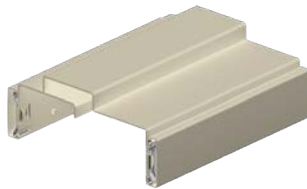

Shown with TA-8 Steel Casing

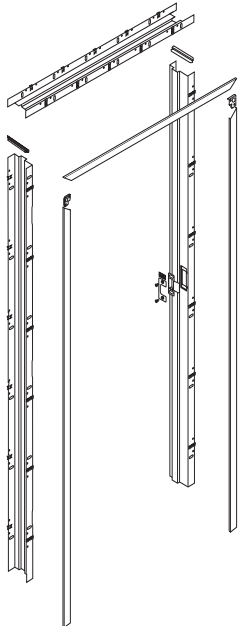
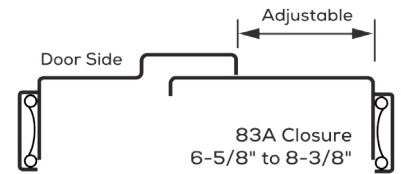
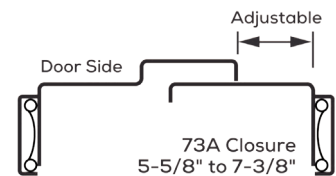
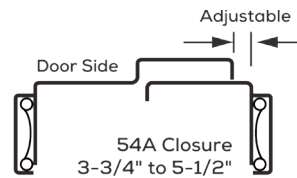

C-SERIES CLASSIC STEEL FRAME

MODEL: Timely C-Series Classic Steel Frame
FIRE RATING: 1-1/2 Hour (90 Minute)
FINISH: Prefinished in Browntone or Western White
FRAME MATERIAL: 18 Gauge Prefinished Hot Dipped Galvanized Steel
INSTALLATION READY: Knock Down
THROAT: 4-5/8", 4-7/8", 6-7/8", or 7-3/8"
HINGES & LOCK STRIKE PREPARATIONS: (3) 4-1/2" Square Corner Hinges and T-Strike Prep
CASING TYPE: Prepped for 2 Sets of Steel Casing (TA-8)
CASING OPTIONS: Colonial (TA-30 Steel), Aluminum (TA-23), Wide Aluminum (TA-28), or Wood
MUTES: Stick-On Rubber Bumper Pads - Rubber Silencer Prep is Available

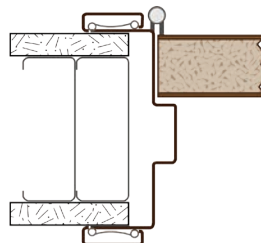

1A Jamb Hinge Side



Shown with TA-8 Steel Casing

COMMERCIAL DOORS

HEAVY DUTY COMMERCIAL APPLICATION

HOLLOW METAL STEEL DOORS



MODEL: 6 Panel Steel Door
 18 Gauge - Galvanized - Polystyrene Core - Primed Gray
SIZES AVAILABLE: 2/8, 2/10, 3/0 x 6/8
 3/0 x 7/0
FIRE RATING: 3 Hour Fire Rating Mylar Label Available
REINFORCED: Closer (16 Gauge, 20" Channel)
 Hinges (10 Gauge Channels)
HINGES PREPARATION: (3) 4-1/2" Square Corner Hinges
LOCK PREP AVAILABLE: 161 Lock Prep
CLOSED TOP CHANNEL
HANDED FOR LEFT OR RIGHT SWING

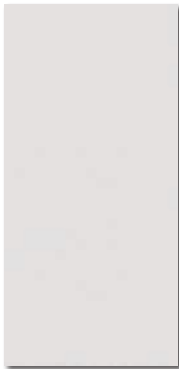

MODEL: Flush Steel Door
 18 Gauge - Galvanized - Polystyrene Core - Primed Gray
SIZES AVAILABLE: 2/6, 2/8, 2/10, 3/6, 4/0 x 6/8 (161 Prep)
 3/0 x 6/8 (161 or 86 Edge Prep)
 2/6, 2/8 x 7/0 (161 Prep)
 3/0, 3/6, 4/0 x 7/0 (161 or 86 Edge Prep)
FIRE RATING: 3 Hour Fire Rating Mylar Label Available
REINFORCED: Closer (16 Gauge, 20" Channel)
 Hinges (10 Gauge Channels)
HINGES PREPARATION: (3) 4-1/2" Square Corner Hinges
LOCK PREP AVAILABLE: 161 Lock Prep
 86 Edge Prep
CLOSED TOP CHANNEL
HANDED FOR LEFT OR RIGHT SWING

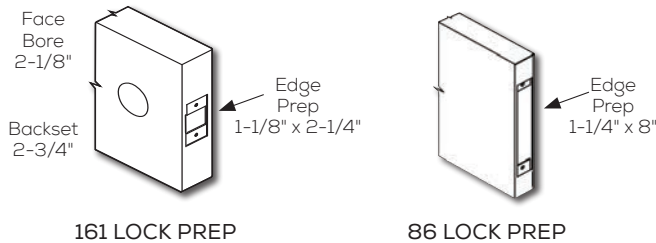

COMMERCIAL DOORS

UNFINISHED FLUSH DOORS

BIRCH

Architectural grade, 5 ply construction in both 20 MIN and 90 MIN fire rating.



ROTARY NATURAL
20 or 90 Minute



ECONOMY
20 Minute only

MODEL: S-20B

SIZES AVAILABLE: Economy Birch Rotary Natural
2/8 x 6/8, 7/0 2/6 x 6/8, 7/0
3/0 x 6/8, 7/0 2/8 x 6/8, 7/0
3/0 x 6/8, 7/0, 8/0 3/6 x 6/8, 7/0

FIRE RATING: 20 Minute

FINISH: Unfinished

BOTTOM RAILS: 2-1/4"

STILES: Economy Birch - soft stile; Rotary Natural - hard stile

UNIT INCLUDES: Standard 161 Cylindrical Lock Prep & Standard Mortise Hinge Prep

MODEL: MC-90B (Rotary Natural Birch only)

SIZES AVAILABLE: 3/0 x 6/8, 7/0

FIRE RATING: 90 Minute

FINISH: Unfinished

BOTTOM RAILS: 2-1/4"

STILES: Hard stile

UNIT INCLUDES: Standard 161 Cylindrical Lock Prep & Standard Mortise Hinge Prep

PLAIN SLICED RED OAK

Architectural grade, 5 ply construction in both 20 MIN and 90 MIN fire rating.



MODEL: S-20B

SIZES AVAILABLE: 2/6 x 6/8, 7/0
2/8 x 6/8, 7/0
3/0 x 6/8, 7/0, 8/0
3/6 x 6/8, 7/0

FIRE RATING: 20 Minute

FINISH: Unfinished

BOTTOM RAILS: 2-1/4", 6" (available in 3/0 x 7/0), 14" (only available in 3/0 x 8/0)

UNIT INCLUDES: Standard 161 Cylindrical Lock Prep & Standard Mortise Hinge Prep

MODEL: MC-90B

SIZES AVAILABLE: 3/0 x 6/8, 7/0, 8/0

FIRE RATING: 90 Minute

FINISH: Unfinished

BOTTOM RAILS: 2-1/4", 14" (only available in 3/0 x 8/0)

UNIT INCLUDES: Standard 161 Cylindrical Lock Prep & Standard Mortise Hinge Prep

FLUSH "STANDARD" PARTICLEBOARD CORE - 20 MIN & FLUSH MINERAL CORE - 90 MIN



FLUSH "STANDARD" PARTICLEBOARD CORE - 20MIN

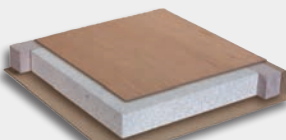

FLUSH MINERAL CORE - 90 MIN

SPECIFICATIONS: 5 Ply construction. Meets or exceeds industry standards of WDMA I.S.1; All 20 Minute doors have been tested in conformance to the following standards. ASTM-E-152, CSFM-43.7, CAN4-S104, NFPA-252, UBC-7-2-97, UL-10C

THICKNESS: 1-3/4"

PARTICLEBOARD (S-20B): 28-30lb Particleboard, ANSI A208.1 Grade LD-1
MINERAL CORE (MC-90B): Gypsum Mineral Core

FIRE RATING: (S-20B) 1-3/4" Thickness 20 Minute Fire Rated*
(MC-90B) 1-3/4" Thickness 90 Minute Fire Rated*

RECOMMENDED USE: Residential and Light Commercial

WARRANTY: Standard two year. See limited warranty for details.

ABBREVIATIONS: S-20B = Standard 1-3/4" Thick PBC, 20 Minute Category B
MC-90B = Mineral Core 90 Minute, Category B

*See fire door specifications section in catalogue for details on sizes, hardware and construction limitations.
Note: See page 7 & 10 in the American Series Flush Wood Door Collection brochure for further details.

COMMERCIAL DOORS

UNFINISHED FLUSH DOORS

QUARTER SLICED AFRICAN MAHOGANY

Architectural grade, 5 ply construction in 20 MIN fire rating.



MODEL: S-20B

SIZES AVAILABLE: 3/0 x 7/0, 8/0

FIRE RATING: 20 Minute

FINISH: Unfinished

BOTTOM RAILS: 6" (available in 3/0 x 7/0), 14" (only available in 3/0 x 8/0)

UNIT INCLUDES: Standard 161 Cylindrical Lock Prep & Standard Mortise Hinge Prep

PLAIN SLICED WHITE MAPLE

Architectural grade, 5 ply construction in both 20 MIN and 90 MIN fire rating.



MODEL: S-20B

SIZES AVAILABLE: 3/0 x 6/8, 7/0, 8/0

FIRE RATING: 20 Minute

FINISH: Unfinished

BOTTOM RAILS: 2-1/4", 6" (available in 3/0 x 7/0), 14" (only available in 3/0 x 8/0)

UNIT INCLUDES: Standard 161 Cylindrical Lock Prep & Standard Mortise Hinge Prep

MODEL: MC-90B

SIZES AVAILABLE: 3/0 x 7/0

FIRE RATING: 90 Minute

FINISH: Unfinished

BOTTOM RAILS: 2-1/4"

UNIT INCLUDES: Standard 161 Cylindrical Lock Prep & Standard Mortise Hinge Prep

FLUSH "STANDARD" PARTICLEBOARD CORE - 20 MIN & FLUSH MINERAL CORE - 90 MIN



FLUSH "STANDARD"
PARTICLEBOARD CORE - 20MIN

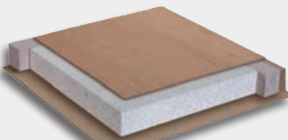

FLUSH MINERAL CORE - 90 MIN

SPECIFICATIONS: 5 Ply construction. Meets or exceeds industry standards of WDMA I.S.1; All 20 Minute doors have been tested in conformance to the following standards. ASTM-E-152, CSFM-43.7,CAN4-S104, NFPA-252, UBC-7-2-97, UL-10C

THICKNESS: 1-3/4"

PARTICLEBOARD (S-20B): 28-30lb Particleboard, ANSI A208.1 Grade LD-1

MINERAL CORE (MC-90B): Gypsum Mineral Core

FIRE RATING: (S-20B) 1-3/4" Thickness 20 Minute Fire Rated*

(MC-90B) 1-3/4" Thickness 90 Minute Fire Rated*

RECOMMENDED USE: Residential and Light Commercial

WARRANTY: Standard two year. See limited warranty for details.

ABBREVIATIONS: S-20B = Standard 1-3/4" Thick PBC, 20 Minute Category B

MC-90B = Mineral Core 90 Minute, Category B

*See fire door specifications section in catalogue for details on sizes, hardware and construction limitations.

Note: See page 7 & 10 in the American Series Flush Wood Door Collection brochure for further details.

COMMERCIAL DOORS

PREFINISHED FLUSH DOORS

PLAIN SLICED RED OAK

Architectural grade, 5 ply construction in 20 MIN fire rating.



MODEL: S-20B
SIZES AVAILABLE: 3/0 x 7/0
FIRE RATING: 20 Minute
FINISH: Prefinished
FINISH OPTIONS: Georgia or Virginia
BOTTOM RAILS: 2-1/4"

UNIT INCLUDES: Standard 161 Cylindrical Lock Prep & Standard Mortise Hinge Prep

PREFINISHED OPTIONS:



Georgia



Virginia

PLAIN SLICED WHITE MAPLE

Architectural grade, 5 ply construction in 20 MIN fire rating.



MODEL: S-20B
SIZES AVAILABLE: 3/0 x 7/0
FIRE RATING: 20 Minute
FINISH: Prefinished
FINISH OPTIONS: Georgia or Virginia
BOTTOM RAILS: 2-1/4"

UNIT INCLUDES: Standard 161 Cylindrical Lock Prep & Standard Mortise Hinge Prep

PREFINISHED OPTIONS:



Georgia

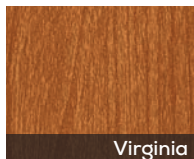

Virginia

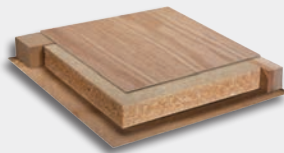

FLUSH "STANDARD" PARTICLEBOARD CORE - 20 MIN

SPECIFICATIONS: 5 Ply construction. Meets or exceeds industry standards of WDMA I.S.1; All 20 Minute doors have been tested in conformance to the following standards. ASTM-E-152, CSFM-43.7, CAN4-S104, NFPA-252, UBC-7-2-97, UL-10C

THICKNESS: 1-3/4"

PARTICLEBOARD: 28-30lb Particleboard, ANSI A208.1 Grade LD-1

FIRE RATING: 1-3/4" Thickness 20 Minute Fire Rated*

RECOMMENDED USE: Residential and Light Commercial

WARRANTY: Standard two year. See limited warranty for details.

ABBREVIATIONS: S-20B = Standard 1-3/4" Thick PBC, 20 Minute Category B

*See fire door specifications section in catalogue for details on sizes, hardware and construction limitations.
Note: See page 7 in the American Series Flush Wood Door Collection brochure for further details.

COMMERCIAL DOORS

PREFINISHED FLUSH DOORS

COLLEDGEGUARD

Architectural grade, 5 ply construction in 20 MIN fire rating.



MODEL: E-20B

SIZES AVAILABLE: 3/0 x 6/8, 7/0

FIRE RATING: 20 Minute

FINISH: Prefinished

FINISH OPTIONS: Wild Cherry, Fusion Maple, or Mariposa Walnut

BOTTOM RAILS: 2-1/4"

UNIT INCLUDES: Standard 161 Cylindrical Lock Prep & Standard Mortise Hinge Prep

PREFINISHED OPTIONS:



Fusion Maple

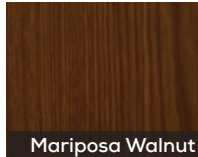

Mariposa Walnut



Wild Cherry

ColledgeGuard Prestained door skins are made from industrial grade higher density fiberboard (HDF) developed and finished in a variety of colors and grain variations.

The HDF board provides a deeper and bolder grain, as well as a smoother and less porous surface.

PRIMED HARDBOARD

Architectural grade, 5 ply construction in 20 MIN fire rating.



MODEL: E-20B

SIZES AVAILABLE: 3/0 x 6/8, 7/0

FIRE RATING: 20 Minute

FINISH: Primed

BOTTOM RAILS: 2-1/4"

UNIT INCLUDES: Standard 161 Cylindrical Lock Prep & Standard Mortise Hinge Prep

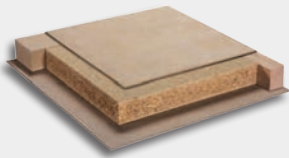

FLUSH "ECONOMY" PARTICLEBOARD CORE FOR COLLEDGEGUARD & PRIMED HARDBOARD DOORS

SPECIFICATIONS: 5 Ply construction. Meets or exceeds industry standards of WDMA I.S.1; All 20 Minute doors have been tested in conformance to the following standards. ASTM-E-152, CSFM-43.7,CAN4-S104, NFPA-252, UBC-7-2-97, UL-10C

THICKNESS: 1-3/4"

PARTICLEBOARD: 28-30lb Particleboard, ANSI A208.1 Grade LD-1

FIRE RATING: 1-3/4" Thickness 20 Minute Fire Rated*

RECOMMENDED USE: Residential and Light Commercial

WARRANTY: Standard two year. See limited warranty for details.

ABBREVIATIONS: E-20B = Economy 1-3/4" Thick PBC, 20 Minute Category B

*See fire door specifications section in catalogue for details on sizes, hardware and construction limitations.
Note: See page 6 in the American Series Flush Wood Door Collection brochure for further details.

COMMERCIAL DOOR OPTIONS

LITES & LOUVERS / HARDWARE OPTIONS

LITES & LOUVERS

MMI DOOR carries a selection of lites and louvers to address most common applications. Our non-rated lites contain clear glass and our fire rated lites have wire glass. Prior to selection, simply determine as to whether or not a fire rating is required. Then choose the shape, size and positioning of the lite or louver you desire. Our Customer Service Representatives can help you through this process.



V
10" x 10" Lite
Available in Non Rated
and Fire Rated Glass



NLS
3" x 33" Lite
4" x 25" Lite
5" x 20" Lite
Available in Non Rated
and Fire Rated Glass



G
22" x 28" (6'8") Lite
22", 24" x 30" (7'0") Lite
Available in Non Rated
and Fire Rated Glass



LVR
24" x 12" Lite
Metal Louver
Not Fire Rated



COMMERCIAL HARDWARE (INTERIOR & EXTERIOR APPLICATION)

MMI DOOR stocks a full line of commercial doors, frames and hardware available for immediate delivery. Many of these items are adaptable to our residential products in this catalog. We offer a variety of commercial hardware such as self closing hinges, automatic door closers, panic devices and more to suit most applications.

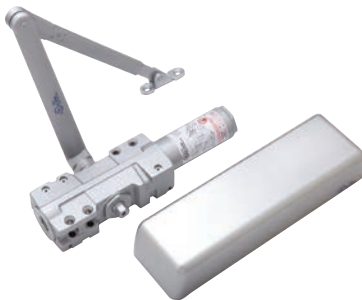

COMMERCIAL DOORS

HARDWARE OPTIONS

Please refer to the MMI DOOR/Doormerica Commercial Hardware Full Product Line Brochure for more information.

1 Hang the Door with Hinges *NRP - Non Removable Pin with set screw



Full Mortise, Standard Weight Hinge
4-1/2" x 4-1/2"
DH179, DHBB179, DHN179*, DHNBB179*



1/4" Radius Corner Standard Weight Hinge
4" x 4"
DHRCBB179

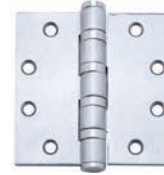

Full Mortise, Heavy Weight Hinge
4-1/2" x 4-1/2"
DHBB168



Commercial Weight Square Corner Spring Hinge
4-1/2" x 4-1/2"
DHSP179



Continuous Geared Aluminum Hinges
83" length
CH882100HD

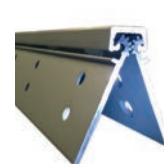

Continuous Geared Aluminum Hinges
83" length
CH882240HD

2 Secure the Door with Locks, Levers, Latches, Strikes, Flush Bolts, and Exit Devices

LOCKS AND LEVERS



Heavy Duty Commercial Mortise Locks



06 For Sectional Trim Specify "A"

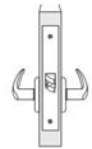

CML9010
Passage/
Closet



CML9040
Privacy/
Bathroom

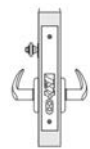

CML9050
Entry/
Office



CML9070
Classroom



CML9080
Storeroom/
Closet



CML9453
Entrance/
Apartment/
Dormitory



700 Series Standard Duty Commercial Deadbolt
Grade 2
DB751, DB760



200 Series Standard Duty Deadbolt
Grade 3
DB251, DB260



Saturn

LHV - Heavy Duty Commercial Cylindrical Locks
Grade 1
LHV10, LHV40, LHV53, LHV70, LHV80



LSV - Standard Duty Commercial Cylindrical Locks
Grade 2
LSV10, LSV40, LSV170, LHV53, LHV70, LHV80

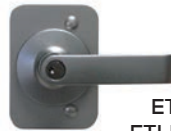

Escutcheon Lever Exit Device Trim
ETLHL500 Entry Function
ETLHL510 Passage Lever Trim
ETLHL580 Storeroom Lever Trim



Escutcheon Lever Design
ETL, ETLBE, ETLNL
Lever: Saturn

DEAD LATCHES AND SPRING LATCHES



PLSVSL238
Grade 2
PLHVS238
Grade 1
2-3/8" Backset
Spring Latch



PLSVDL238
Grade 2
PLHVDL238
Grade 1
2-3/8" Backset
Dead Latch



PLSVSL234
Grade 2
PLHVS234
Grade 1
2-3/4" Backset
Spring Latch



PLSVDL234
Grade 2
PLHVDL234
Grade 1
2-3/4" Backset
Dead Latch



Roller Latch RL300

STRIKES



PLKASA
4-7/8" x 1-1/4"
ASA



PLKT
2-3/4" x 1-1/4"
"T" Strike



PLKFL
2-1/4" x 1-1/4"
Full Lip Strike



CM478STRKFILPLT
4-7/8"
Strike Filler Plate



CMEDGEFILLPLT86
8" (with screws)
86 Edge Plate



CMEDGEFILLPLT161
2-3/4" (with screws)
86 Edge Plate

COMMERCIAL DOORS

HARDWARE OPTIONS

EXIT DEVICES

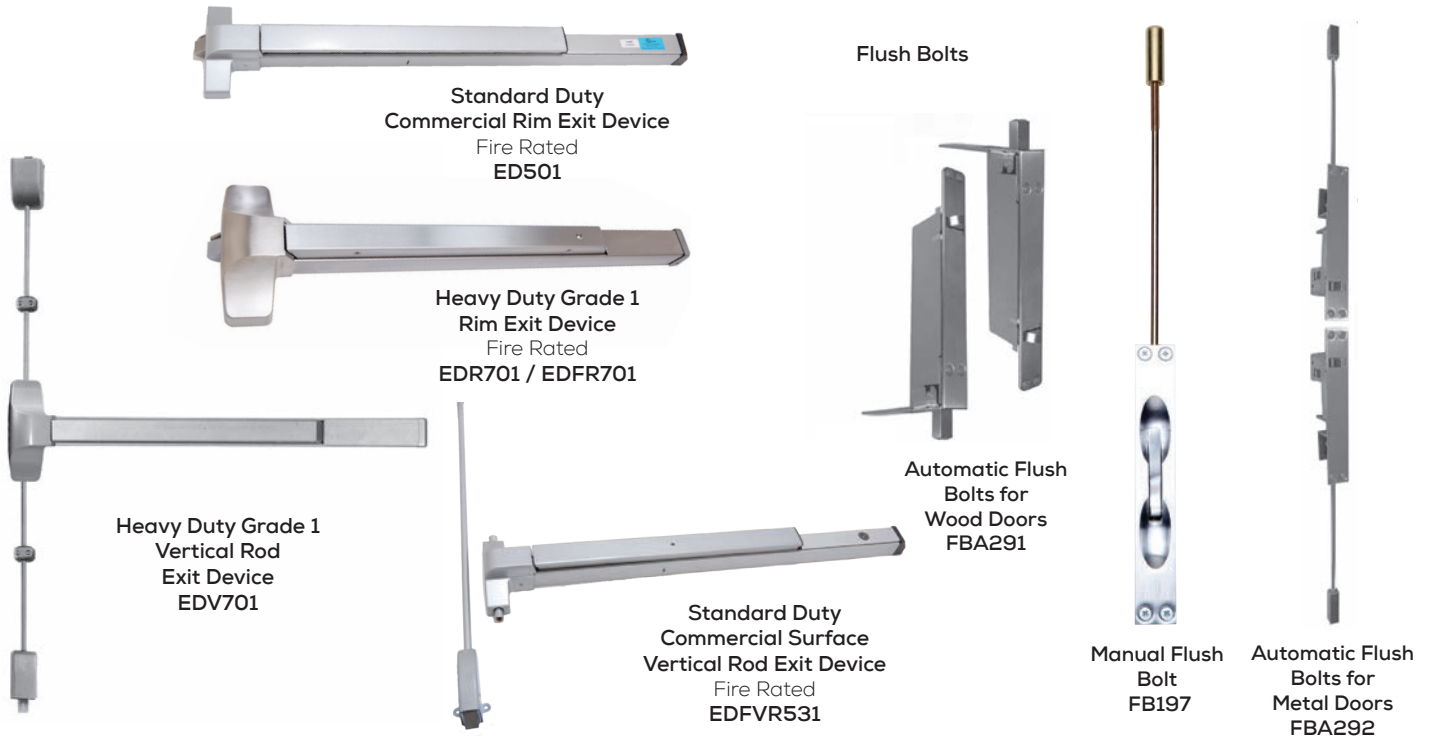

3 Control the Door with Closers



4 Protect the Door with Viewers, Kick Plates, Holders, Pushes and Pulls, Wall Stops, and Floor Stops

VIEWER



KICK PLATES



HOLDERS



WALL STOP



COMMERCIAL DOORS

HARDWARE OPTIONS & PRE-FINISH PROGRAM

FLOOR STOPS



Low Dome
Floor Stop
SH436



High Dome
Floor Stop
SH438



Floor Mount
Stop
SH444

PUSHES AND PULLS



PPN4016R
6" Round Pull



PPN4016R8
8" Round Pull



PPN4016
Push

5 Seal the Door with Weatherstrip, Sweep and Threshold

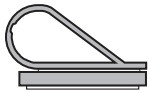

Weatherstrip
Adhesive Back
20 ft. roll
CMADHSVWS200



Weatherstrip
Perimeter Gasket
6/0 x 7/0 set
CMWSMILL6070

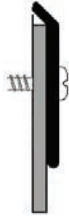

Sweep
3 ft. and
4 ft.
CMSWP30
CMSWP40

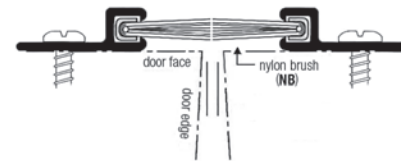

Split Astragal
84"
CMSPLTAST



Threshold
ADA Compliant
1/2" x 5" x 3 ft., 4 ft., 8 6 ft.
5SDLTHRESH30, 5SDLTHRESH40,
5SDLTHRESH60

Please refer to the MMI DOOR / Doormerica Commercial Hardware Full Product Line Brochure for more information.

STANDARD PAINT COLORS



Alabaster



Wicker

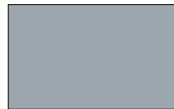

Storm Cloud



Burgundy



Naval



Red Saffron



Brilliant White



Graystone White



Hunter Green



Bronze



Brown



Black

BOLD PAINT COLORS



Tangerine



Yellow Flash



Green Apple



Bahama Blue



Utah Blue



Purple Orchid



Pink Hibiscus



LIGHT COMMERCIAL DOORS

FIRE RATING **20 MIN** 20 MINUTE FIRE RATED DOORS

Residential style with commercial grade safety for your home. **Sized and prepped for wood. Timely steel frames available.**

• **Applications:** Apartments, hotels/motels, assisted living facilities, safe rooms, home offices, storage/furnace rooms, house to garage doors.

• **19 Paint Colors Available** (Steel & Fiberglass Doors Only)

• **Frame Options:** In-stock

20 MIN Fire Rated Wood Frames

STEEL & FIBERGLASS 20 MINUTE FIRE DOORS

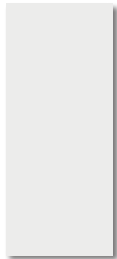

MJ 1
Majestic Steel
Flush
2/6 x 6/8
2/8 x 6/8
2/10 x 6/8
3/0 x 6/8
3/6 x 6/8
2/8 x 7/0
3/0 x 7/0



MJ 20
Majestic Steel
2 Panel
2/8 x 6/8
3/0 x 6/8
2/8 x 7/0
3/0 x 7/0



MJ 21
Majestic Steel
6 Panel
2/6 x 6/8
2/8 x 6/8
2/10 x 6/8
3/0 x 6/8
3/6 x 6/8
3/0 x 7/0



MJ 22
Majestic Steel
2 Panel
Arch Top
2/8 x 6/8
3/0 x 6/8



MJ 40
Majestic Steel
4 Panel
2/8 x 6/8
3/0 x 6/8



MJ CR1
Majestic Steel
1 Flat Panel
2/8 x 6/8
2/10 x 6/8
3/0 x 6/8

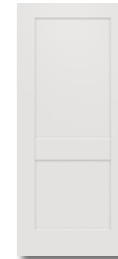

MJ CR2
Majestic Steel
2 Flat Panel
2/8 x 6/8
2/10 x 6/8
3/0 x 6/8



MJ CR3
Majestic Steel
3 Flat Panel
2/8 x 6/8
2/10 x 6/8
3/0 x 6/8



FS 20
Fiberglass
Smooth
2 Panel
2/8 x 6/8
3/0 x 6/8



FS 21
Fiberglass
Smooth
6 Panel
2/8 x 6/8
3/0 x 6/8



FS 22
Fiberglass
Smooth
2 Panel
Arch Top
2/8 x 6/8
3/0 x 6/8



FS 200
Fiberglass
Smooth
2 Panel
Arch Top Planked
2/8 x 6/8
3/0 x 6/8



FS 10 SHK
Fiberglass
Smooth
1 Flat Panel
Craftsman
2/8 x 6/8
3/0 x 6/8



FS 20 SHK
Fiberglass
Smooth
2 Flat Panel
Craftsman
2/8 x 6/8
3/0 x 6/8



FS 30 SHK
Fiberglass
Smooth
3 Flat Panel
Craftsman
2/8 x 6/8
3/0 x 6/8

MOLDED FIRE DOOR UNITS **20 MIN**

- Available complete with Fire Rated frame
- Solid core
- Machining option
- 20 Minute NAMI Fire Label applied to door panel
- 60 Minute molded rated doors available in raised panel styles



Smooth Surface
BIRKDALE
Craftsman
Sticking
3 Flat Panel
2/6 x 6/8*
2/8 x 6/8
3/0 x 6/8



Smooth Surface
CAIMAN
Cove & Bead
Sticking
2 Panel
Arch Top
2/8 x 6/8



Smooth Surface
CARRARA
Cove & Bead
Sticking
2 Panel
2/8 x 6/8
3/0 x 6/8*
3/0 x 7/0*



Smooth Surface
CRAFTSMAN
Craftsman
Sticking
3 Flat Panel
2/8 x 6/8



Smooth Surface
CONMORE
Stepped
Sticking
5 Flat Panel
2/8 x 6/8



Smooth Surface
ROCKPORT
Cove & Bead
Sticking
5 Panel
2/8 x 6/8



Smooth Surface
SANTA FE
Ovolo
Sticking
2 Panel
Arch Top Planked
2/8 x 6/8



Smooth Surface
SMOOTH COLONIST*
Cove & Bead
Sticking
6 Panel
3/0 x 6/8

*Available as Special Order

LIGHT COMMERCIAL DOORS

90 MINUTE FIRE RATED DOORS

FIRE RATING **90 MIN**

90 MINUTE FIRE DOORS

Used with Steel Frames.

Must purchase 1 package of Thru Bolts (SN134) to apply door closer because of mineral core in wood door.

*Special Order Only



S-90B
Rotary
Natural Birch
Wood
Flush
3/0 x 6/8
3/0 x 7/0



S-90B
Plain Sliced
Red Oak
Wood
Flush
3/0 x 6/8
3/0 x 7/0
3/0 x 8/0



S-90B
Plain Sliced
White Maple
Wood
Flush
3/0 x 7/0

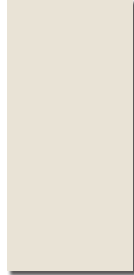

MJ 1
Majestic Steel
24 Gauge Flush
2/6 x 6/8
2/8 x 6/8
2/10 x 6/8
3/0 x 6/8
3/6 x 6/8
2/8 x 7/0
3/0 x 7/0



MJ 21
Majestic Steel
24 Gauge
6 Panel
2/6 x 6/8
2/8 x 6/8
2/10 x 6/8
3/0 x 6/8
3/6 x 6/8
3/0 x 7/0

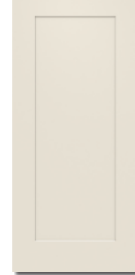

MJ CR10*
Majestic Steel
24 Gauge
1 Panel
2/8 x 6/8
2/10 x 6/8
3/0 x 6/8



MJ CR20*
Majestic Steel
24 Gauge
2 Panel
2/8 x 6/8
2/10 x 6/8
3/0 x 6/8



MJ CR30*
Majestic Steel
24 Gauge
3 Panel
2/8 x 6/8
2/10 x 6/8
3/0 x 6/8



MJ 22
Majestic Steel
24 Gauge
2 Panel Arch
2/8 x 6/8
3/0 x 6/8



MJ 20
Majestic Steel
24 Gauge
True
2 Panel
2/8 x 6/8
3/0 x 6/8
2/8 x 7/0
3/0 x 7/0



MJ 40
Majestic Steel
24 Gauge
4 Panel
2/8 x 6/8
3/0 x 6/8

90 MIN REINFORCED DOORS FOR HARDWARE

** Reinforcements for closers & exit devices
(Suited for hardware applications)

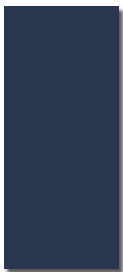

MJ 1R**
Majestic Steel
24 Gauge
Flush
2/8 x 6/8
3/0 x 6/8



MJ 21R**
Majestic Steel
24 Gauge
6 Panel
2/8 x 6/8
3/0 x 6/8
3/6 x 6/8



RESIDENTIAL STEEL FRAMES

LIGHT COMMERCIAL DOORS

Residential styling, commercial grade safety for your home. Sized and prepped for wood, IDP K2A Steel Frames.

- **Applications:** Apartments, hotels/motels, assisted living facilities, safe rooms, home offices, storage/furnace rooms, house to garage doors.
- **Frame Options:** In-Stock
90 MIN Fire Rated 18 gauge adjustable



EZ FLEX ADJUSTABLE FRAME

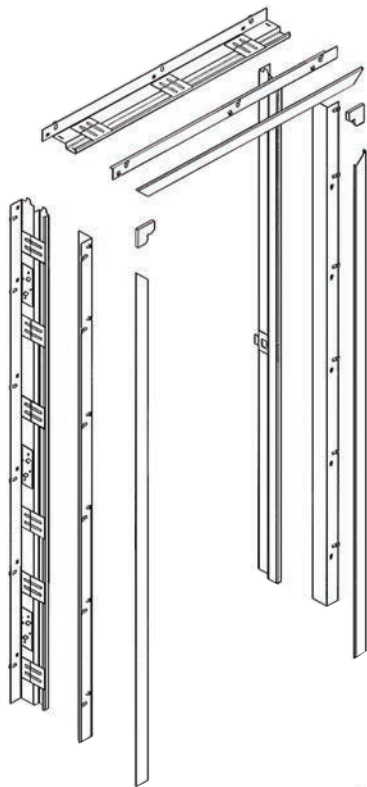

MODEL: EZ Flex Frame, 1-3/4 doors only 5/8" stop height
FIRE RATING: (90 Minute) Fire Rating NAMI Label
FRAME MATERIAL: 18 Gauge Steel Adjustable Split Frame
INSTALLATION READY: Shipped Prehung or Knocked Down
FRAME SIZES AVAILABLE: 3 adjustable frame sizes:
 4-1/2"-5-1/2", 5-1/2"-6-1/2", 6-1/2"-7-1/2"
*1" adjustments, special/custom sizes are available**
HINGES & LOCK STRIKE PREPARATIONS: Hinge Prep for 4", 2-3/4" deadbolt prep and 2-3/4" adjustable T-strike prep
HANDED FOR LEFT OR RIGHT SWING

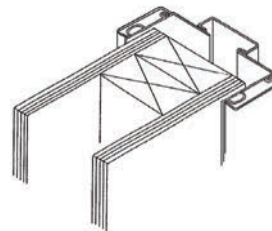

Universal Application
 (Adjustable Split Frame - Interior & Exterior Application)

EZ FLEX®
Steel Frame

Main frames are 18 gauge and closure trim is 22 gauge for walls up to 7-1/2" walls over 7-1/2" is 18 gauge.

* Stock sizes may vary between distribution centers

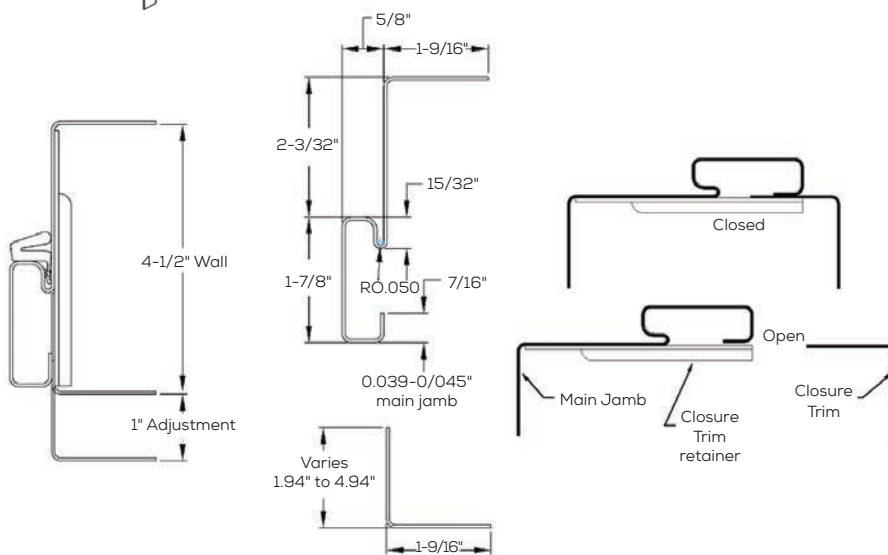

22 gauge or 18 gauge Closure Trim
 walls up to 7-1/2" - 22 gauge
 walls over 7-1/2" - 18 gauge

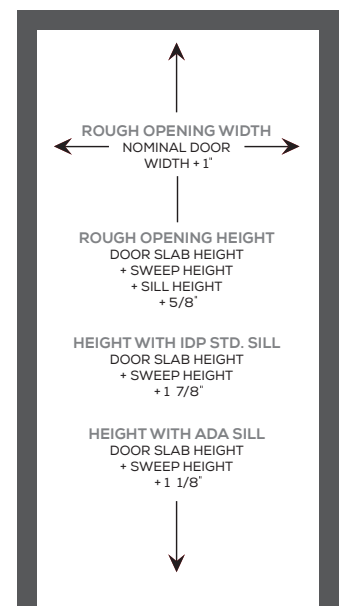

FIBERGLASS FLUSH GLAZED

ADA COMPLIANCE - SPECIAL ORDER ONLY



Sizes:
3/0, 3/6 & 4/0 x 6/8
3/0, 3/6 & 4/0 x 7/0
3/0, 3/6 & 4/0 x 8/0

SPECIAL ORDER

MMI DOOR prides itself on the simple idea of "One Source, One Solution." If we don't stock it, we have a vast amount of resources at our disposal. The possibilities are endless when it comes to commercial doors and hardware. Below is a small sample of additional doors, frames and hardware we can provide:

DOORS

Besides our stock profiles, **Hollow Metal** and **Wood Doors** can be ordered in a variety of styles, as shown below. Special Order **Hollow Metal** can be ordered in **12, 14, 16** and **18** gauge, in cold rolled, galvanized **Stainless Steel, Lead Lined, Sound Resistant** and **Bullet Resistant**. **Wood Doors** can be ordered in any veneer of choice, **Prefinished, Sound Resistant** and **Lead Lined**.

FLUSH DESIGNS

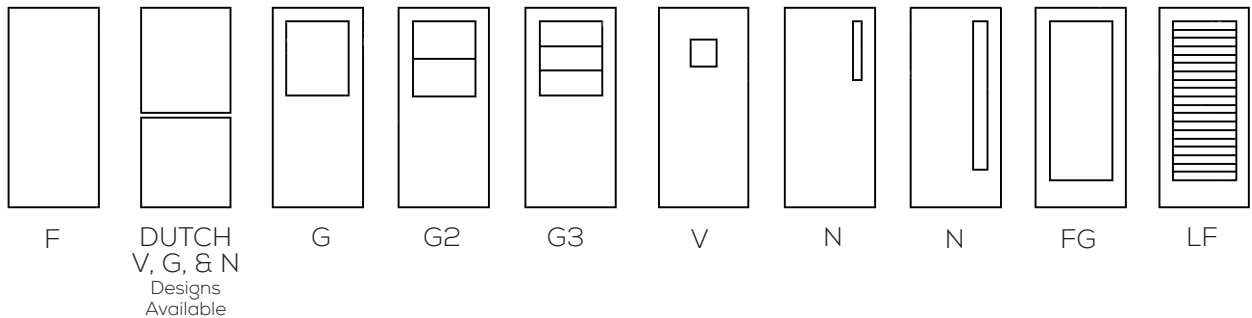

EMBOSSED PANEL DESIGNS

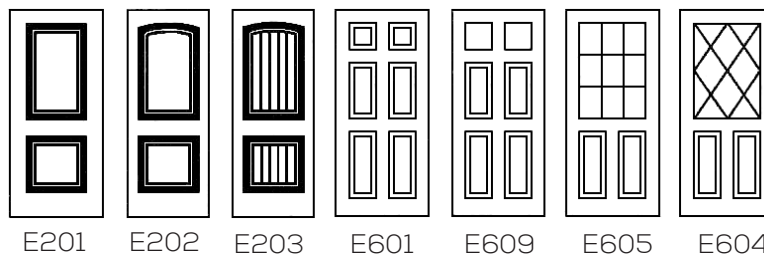

FRAMES

Special order **Hollow Metal** frames can be ordered in **12, 14** and **16** gauge cold rolled or galvanized, **Stainless Steel, Lead Lined**, knocked down or welded. 3 sided, **Sidelite, Transom** or **Borrowed Lites**. Available in **18** gauge pre-finished or unfinished through Timely. Frames can be ordered to fit the wall conditions you require, from **3" to 14" thick**.

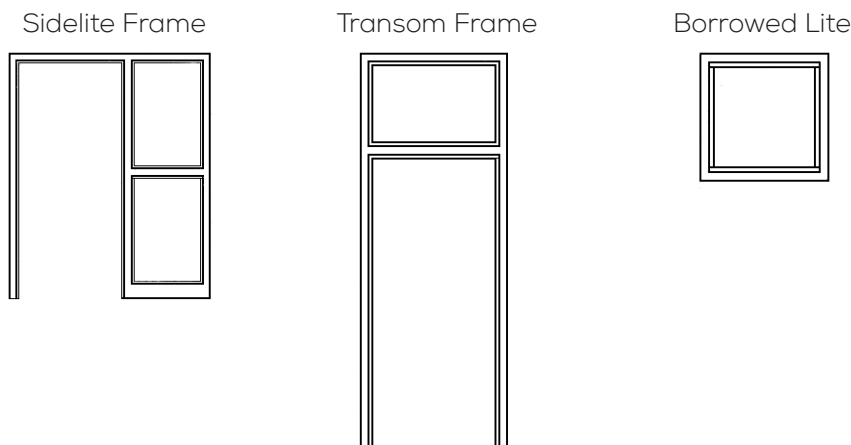

FINISHED HARDWARE

Our complete line of hardware doesn't stop with what we stock, we have access to all major brands and types, including **Concealed Hardware, Electric Hardware, Pivots, Auto-Operators, Alarm Devices** and much more.

GLOSSARY OF TERMS

At first glance, commercial doors and products can seem intimidating. Familiarizing yourself with the products, field applications and terminology can be a big help. Below are examples of some popular, everyday commercial products, their commercial door application and glossary to clarify common terms.

Our goal is to make commercial products easy to sell, source and service!



- Active Door** The leaf that opens first and the one to which the lock is applied.
- Astragal** (in a pair of doors) A molding or strip whose purpose is to cover or close the gap between the edges of a pair of doors. Some types overlap, others meet at the center line of the gap.
- Ball Bearing Hinge** A hinge that is equipped with ball bearings between the hinge knuckles that reduces friction. Mainly used for heavy doors for ease of opening.
- Continuous Hinge** (also called Piano Hinge) A hinge designed to be the same length as the moving part to which it is applied, for example, the lid covering the keyboard of a piano.
- Coordinator** A device used on a pair of doors to ensure that the inactive leaf is permitted to close before the active leaf. Necessary when an overlapping astragal is present and exit devices, automatic or self-latching bolts are used with closers on both door leaves.
- Cylinder** The cylinder-shaped assembly (complete operating unit) containing the tumbler mechanism and the keyway (plug, shell, tumblers, springs and actuating device) into which the key is inserted to operate a lock and can only be actuated by the correct key.
- Door Hand** A term to describe the direction a door swings - Example RH - right hand or RHR - right hand reverse.
- Door Stop** A device to stop the swing or movement of a door at a certain point.
- Dust-Proof Strike** A strike with a spring plunger that completely fills the bolt hole when the bolt is not projected.
- Exit Device** A door-locking device designed to grant instant exit by pressing on a cross bar that releases the locking bolt and latch.

- Flush Bolt** A door bolt, that when applied, is flush with the face or edge of the door.
- Inactive Door** (or Leaf) That leaf of a pair of doors that does not contain a lock, is bolted when closed, and to which the strike is fastened to receive the latch or bolt of the active door.
- Kick Plate** A protective plate applied on the lower rail of the door to prevent the door from being marred.
- Lock Set** (or Latch) A lockset, complete with trim, such as knobs, escutcheons or handles.
- Mortise Lock** (Hall/Closet) A lock which is mortised into the edge of a door which combines the two functions normally required on a door; latching and bolting.
- Passage Function** (Bed/Bath) Knob or lever set most commonly used in hallways where a locking feature is not required.
- Privacy Function** Knob or lever set most commonly used in bathroom or bedroom; can be locked from the inside with a push button emergency release feature.
- Push Plate** A plate applied to the lock stile to protect the door against soiling and wear.
- Pull Plate** A plate applied to the lock stile to grab and pull the door open and also protect the door against soiling and wear.
- Spring Hinge** A hinge containing one or more springs to move the door into the desired position. It may be either single or double acting.
- Threshold** A strip fastened to the floor beneath a door, usually required to cover the joint where two types of floor materials meet.

ORDER YOUR DOOR

CHECKLIST FORM

The following checklist will be useful in gathering complete quoting/ordering information

Customer Name: _____ Job Name: _____

APPLICATION: Interior Exterior

FRAMES

Opening Size: _____ W _____ H Nominal Rough Existing

Wall Type: New Existing Masonry Wood Stud Metal Stud

Finished Wall Thickness: _____ Frame Depth _____ Overall Throat

Frame Type: Masonry Drywall Expandable

Corner Construction: Knocked Down Set-up/Welded *Note: Drywall and Expandable are KD only*

Anchors: Wire Masonry Wood Stud Metal Stud Existing Opening with expansion bolt or wood screws.
(Punched and Dimpled)

Gauge: Standard 16/18 Special - Specify _____

Fire Rating: B label (1-1/2 hour) C label (45 minute) (20 minute) (non-rated)

Finish: Field Finish (by customer) Prefinished Color _____

Steel Type: Cold Rolled Galvanized Galvaneal Other - Specify _____

Handings: Single

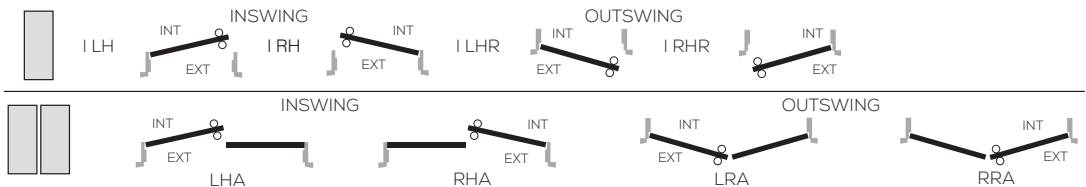

Double

DOORS

Type: HM Polystyrene Light Commercial MJ Steel Oak Birch Fiberglass

Design: Flush 2 Panel 6 Panel Metal Lite 10x10 5x20 3x33 6x30 22x28 22x30 24x20

Gauge: Standard 18/25 Special Specify _____ Louver Other: _____

Fire Label: B label (1-1/2 hour) C label (45 minute) (20 minute) (non-rated)

Opening: Single Door Pair of Doors

Astragal: WITH Astragal WITHOUT Astragal

Finish: Field Finish Prefinished Color _____

HARDWARE

Finish: _____

Hinges: Plain Bearing Plain NRP Ball Bearing Ball Bearing NRP Spring

Door Closer: Heavy Traffic - 2701 Light Traffic - 1101

Exit Device: Rim Heavy Traffic - 2100 SVR Heavy Traffic - 2110 RIM Light Traffic - 1800 SVR Light Traffic - 1810

Panic Trim: Rose Passage Rose Classroom Escutcheon Classroom Other _____

Misc. Hardware: ADA Threshold Flush Bolts Perimeter Weatherstrip Viewer Adhesive Weatherstrip

Sweep Push Plate Pull Plate Kick Plate Wall Stop Dome Stop Kick Down Stop Split Astragal

Commercial Cylindrical Lock: Passage Privacy Entry Classroom Storage Single Cylinder Deadbolt

If Hardware is to be supplied by others:

Lock Brand: _____ Lock Type:  Cylindrical  Deadbolt  Mortise

Lock Function: _____ Lock Number: _____ Finish: _____

For more information on MMI DOOR
products and services, please visit:
www.mmidoor.com



MMi DOOR LOCATIONS

Michigan (HQ)

6361 Sterling Drive North
Sterling Heights, MI 48312
586.264.0950
800.686.9218
Fax: 586.264.5430

Ohio

400 Circle Freeway Drive
Cincinnati, OH 45246
513.874.6771
800.215.3770
Fax: 513.870.0242

Pennsylvania

172 Plummer Road
Sidman, PA 15955
814.487.7800
800.452.0251
Fax: 814.487.7850

© 2022 MMI DOOR All Rights Reserved.
MMICOMBROCH • 04/22

20 CRF 90M
ETLHL500
Finished in Field